



# Ventura 150/200T

## Installation and Operating Manual



Spectra Watermakers

Katadyn Desalination LLC.

2220 S. McDowell Blvd. Ext. Petaluma, CA 94954

Phone: 415-526-2780 Fax: 415-526-2787

[techsupport@spectrawatermakers.com](mailto:techsupport@spectrawatermakers.com)





## Table of Contents

Getting Started .....	5
<b>Installation</b> .....	<b>7</b>
Introduction.....	9
Installation Basics .....	10
Ventura Plumbing .....	11
Product Water and Pressure Gauge Tube Installation .....	12
Parker Tube Fitting Assembly Procedure .....	13
John Guest Tube Fitting Assembly Procedure.....	14
Spectra High Pressure Fitting Instructions .....	15
Wiring.....	16
Optional Z-Ion Installation and Instructions.....	17
<b>Operation</b> .....	<b>23</b>
New Systems Start Up Procedure.....	25
Dry Testing with an Artificial Ocean .....	26
Normal Operation and Fresh Water Flush .....	27
Optimizing the Fresh Water Flush Duration .....	28
<b>Maintenance, Storage, and Troubleshooting</b> .....	<b>29</b>
Suggested Spares .....	31
Maintenance.....	32
Introduction to Spectra Chemicals .....	34
Storage Procedure .....	36
Winterizing with Propylene Glycol .....	37
Membrane Cleaning Procedure .....	38
Ventura Flow Test .....	39
Troubleshooting .....	41
Technical Bulletins.....	42
Parts Identification .....	48



# Getting Started

Unpack the system and inspect it for damage during shipping. Freight damage must be reported within 24 hours.

Refer to the shipping list for your system to ensure you received all of the components listed. Do not discard any packaging until you have found and identified all of the parts. The small installation parts are listed on the kit list.

***Warning! We will not be held responsible for shortages that are not reported within thirty days of the ship date.***

Study the system layout diagram, component photos, and descriptions before beginning installation.

Lay out the system. Before starting the installation identify where each module and component will be placed. Ensure that there is enough clearance around the components for removal of filters and system service. Make sure you have adequate tubing and hose before starting. Additional parts may be ordered.

*THE VENTURA 200T IS DESIGNED FOR WARM WATER USE. OPERATION IN WATERS BELOW 50° F (10° C) MAY CAUSE HIGH OPERATING PRESSURES AND INCREASED WEAR ON THE FEED PUMP*

## Ventura Shipping List

- High Pressure Clark Pump and Reverse Osmosis Membrane Module
- Inlet Feed Pump Module with Fresh Water Flush System
- Accumulator Tank
- Manual
- Analog Gauge Assembly
- Installation Fittings Kit
- 5/8" Hose (2 x 25')
- Service Kit





# Installation





# Introduction to the Ventura

The Ventura is the finest watermaker for small and mid-sized yachts. Properly installed and maintained it will provide years of reliable service. Prudent operation is required with any marine equipment. **Always maintain enough reserve water to get safely into your next port.**

The Spectra Intensifier, known as the Clark Pump, was introduced in 1997 and has been continually improved since. It is built of modern non-corrosive composites and comes with a 20" high rejection membrane.

## Front View

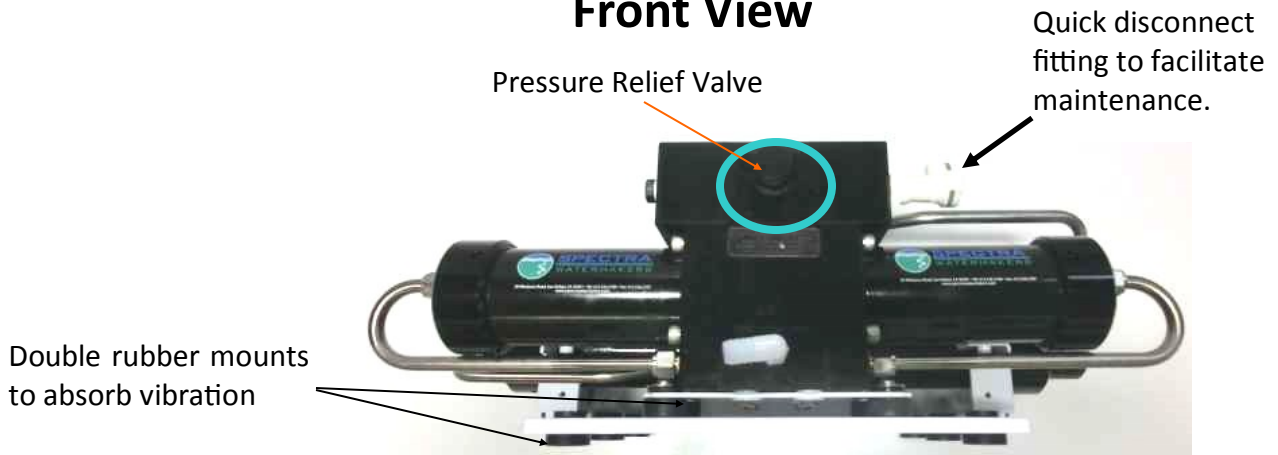

## Rear View

The Clark Pump Membrane Module. Pre-mounted and plumbed together as a single unit. Saves time and adds reliability.



### Ventura Feed Pump Module

Includes the feed pump, cooling fan, charcoal filter, flush valve, service valve, and service port. The module has compact and streamlined plumbing. The cooling fan is included for longevity.

**Note: If your system came with the optional Z-Ion, the Z-Ion unit will replace the charcoal filter housing. The photo above, and all subsequent photos of the Feed Pump Module, will look slightly different.**

## Installation Basics

- **Read the directions!**
- Avoid tight hose bends and excessive runs.
- Use heavy gauge wire.
- Install feed pump module as low as possible.
- Use a dedicated thru-hull with scoop type strainer.
- Do not mount components over electrical devices.
- **Avoid getting dirt or debris into the piping or hoses during assembly.** A small bit of debris can stop the system!

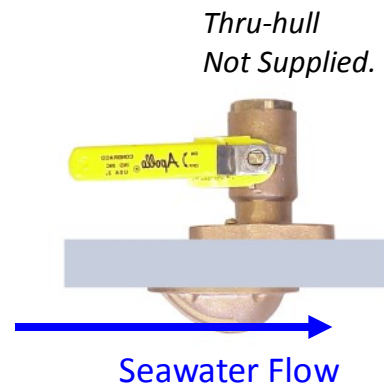

**Thru-hull Location:** The system must be connected to a dedicated 1/2" to 3/4" forward facing scoop-type intake thru-hull and seacock.

Install the thru-hull intake as far below the waterline and as close to centerline as possible to prevent air or contamination from entering the system. Do not install the intake close to, or downstream of a head discharge, keel, stabilizer fins, or other underwater fixtures.

Thru-hulls near the bow are susceptible to air intake in rough conditions. Sharing a thru-hull can cause flow restrictions, intake of air bubbles or contaminants, and will void the warranty. For racing boats and high speed boats traveling above 15 knots, a retractable, snorkel-type thru-hull fitting is preferred because it picks up water away from the hull.

**The brine discharge thru-hull** should be above the waterline, along or just above the boot stripe, to minimize water lift and back pressure.

Double clamp all hose connections below the waterline.

Avoid restrictions or long hose runs along the intake plumbing, from the thru-hull to the feed pump module.

Secure the piping away from moving objects such as engine belts and hatches. Prevent chafe on the tubing as required. After several hours of operation, inspect all piping and hose clamps for leaks.

**Pipe Fitting Instructions:** To seal plastic-to-plastic fittings, wrap 6 to 8 layers of Teflon tape around the threads. Hold the fitting in your left hand and tightly wrap the threads clockwise. For smoother assembly, do not tape the first (starting) threads.

### Wiring

- Pay attention to wire size or system performance will be impaired
- Perform wiring to UL, ABYC, CE or applicable standards

# Ventura Plumbing



**Brine discharge thru hull (not included):** place above waterline or tee into another visible drain.

Note: Brine discharge may be connected to either side of Clark Pump

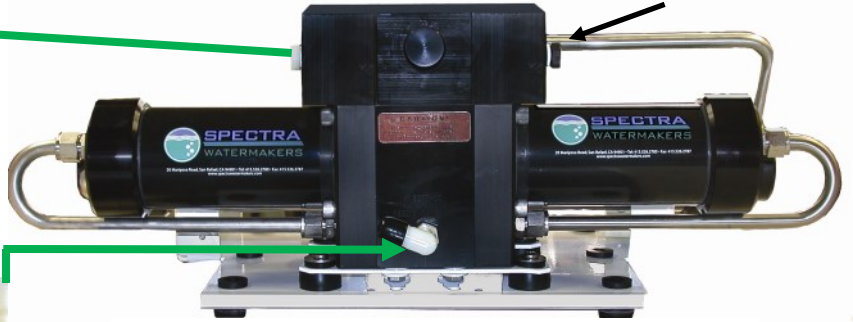

**Spectra Clark Pump and Pressure Vessel/Membrane:** Mount in a cool location (below 120 deg. F/49 deg. C). May be oriented in any position and can be well above waterline. Leave access to the pressure relief valve. Do not mount over electrical equipment. Use supplied spacers and washers for the vibration mounts.



**Accumulator:**  
Factory pre-charged



Use the supplied 5/8-inch (15.9mm) clear braided vinyl hose for all runs. More hose may be ordered from Spectra, or bought at a hardware or marine store.



**5 micron filter:**  
Do not mount over electrical equipment. Leave clearance below for filter changes.

**Fresh Water Flush inlet to charcoal filter:**  
Plumb to the pressurized side fresh water system.



**Sea Strainer:** Mount with included Quick Block

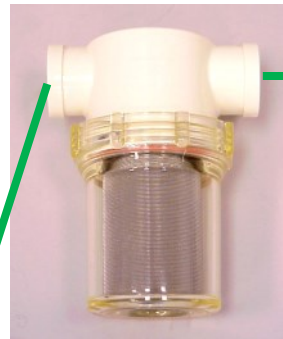

**Feed Pump Module:** Mount vertically as low as practical, no more than 3' (1M) above waterline and not over electrical equipment. Leave clearance below for filter changes.

**1/2" or 3/4" scoop strainer thru-hull and Seacock:** Mount low, in a clear flow and away from head discharge.



# Product Water Plumbing and Pressure Gauge Tube Installation

**Sampling Tap** for testing the product water.

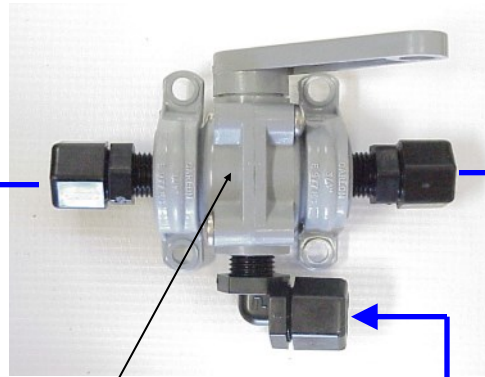

**Product to tank:** Route the product water from the valve into the top of a vented tank. Install a tee in the water fill or tap a pipe thread into an inspection port.

**DO NOT!** feed the product into a vent line, manifold, or the bottom of the tank. Make sure that there is no restriction in this piping. **Pressure in the product tubing must never exceed 5psi (.3bar)**, running or stopped, or the membrane will be permanently damaged.

**Product Sampling Valve:** Mount using the supplied plastic straps as shown. **Note: the handle points in the direction of flow.**



Use accumulator port to connect the pressure gauge with the supplied 1/4" black nylon tubing. Tubing must be pressure rated to 150 PSI (10 BAR).

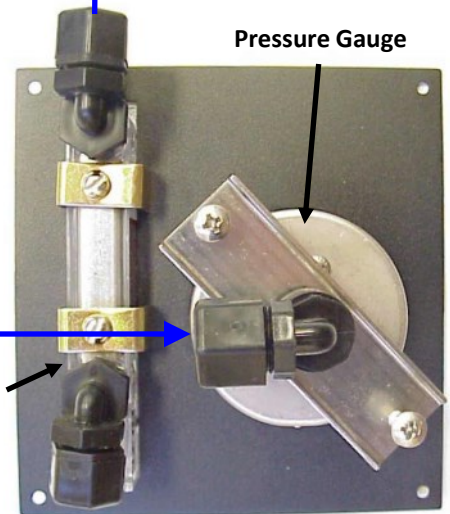

**Pressure Gauge**

**Product Flow Meter**

Back view of instrument panel

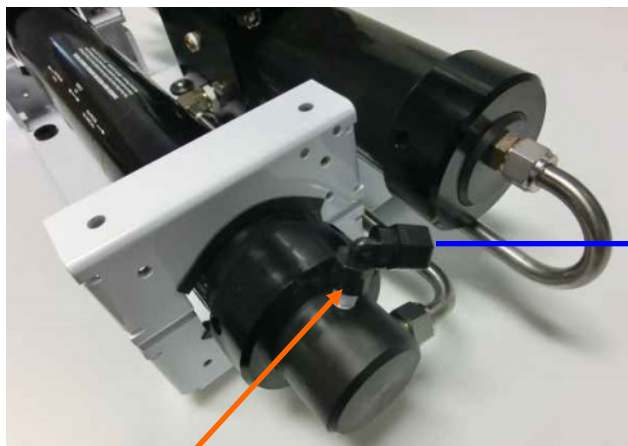

Use the supplied 1/4" black nylon tubing for the product plumbing.

Product output fitting.

# Parker Tube Fitting Assembly Procedure

## Fast & Tite® Thermoplastic Fittings

Fast & Tite® fittings are the most complete line of plastic fittings for thermoplastic tubing in the industry.

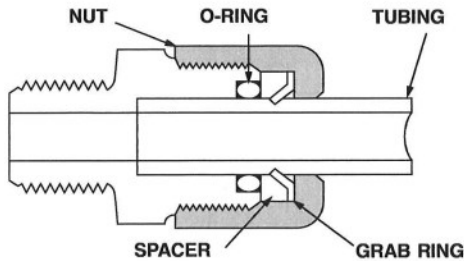

Fast & Tite® thermoplastic tube fittings from Parker will prove to be the answer to your tubing connector needs. Patented Fast & Tite® fittings install in seconds without tools and provide a tight, sure, leak proof seal without clamps or adjustments. A unique 302 stainless steel grab ring for tube retention, coupled with a Nitrile O-Ring for positive seal, assures good tube connection with only hand tight assembly. A plastic grab ring is also available upon special request. Vibration or tube movement will not break the seal and cause leakage. Preassembled in either highly inert polypropylene, or strong, durable nylon, Fast & Tite® fittings are the answer to full flow thermoplastic tubing system requirements.

When necessary, Fast & Tite® fittings can be disassembled by hand for fast system drainage. Fittings are completely reusable.

Parts are easily replaced. O-Rings are standard size and universally available. (For applications requiring other than Nitrile O-Rings, consult your Fast & Tite® distributor.)

Use Fast & Tite® fittings with Parker Parflex tubing or other plastic, glass or metal tubing for low pressure or vacuum lines up to the pressure limits shown below.

Fast & Tite® fittings meet FDA and NSF-51 requirements for food contact.

### Working Pressures for Fast & Tite® Fittings

Tube O. D., in.	Air-Oil-Water Pressure in PSI		
	Up to 75°F	76° to 125°F	126° to 175°F
1/4	300	300	300
5/16	300	300	300
3/8	250	250	150
1/2	200	200	150
5/8	150	100	50

Ratings are based on use with copper tubing, and in all cases represent the maximum recommended working pressure of the fitting only. Working pressures (vs. temperatures) of other types of tubing may limit the tube and fitting assembly to pressures lower than shown above. Consult factory for recommendations on applications other than shown above.

### Temperature Range:

Black/White Polypropylene: 0°F (-18°C) to +212°F (+100°C)

White Nylon: -40°F (-40°C) to +200°F (+93°C)

## Fast Assembly

### Step 1.

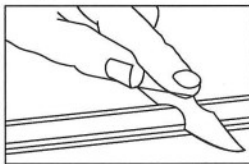

Cut the tube squarely and remove any burrs.

### Step 2.

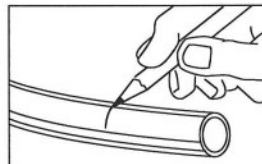

Mark from end of tube the length of insertion. (See table below)

Tube O.D. (in.)	Insertion Length with Tube Support (in.)	Insertion Length without Tube Support (in.)
1/4	5/8	9/16
5/16	5/8	9/16
3/8	13/16	3/4
1/2	7/8	13/16
5/8	1	15/16

### Step 3.

Loosen nut on fitting until three threads are visible. Fittings for glass tubes must be disassembled and the grab ring removed.

### Step 4.

Moisten end of the tube with water. Push the tube **Straight** into fitting until it bottoms on the fitting's shoulder. Tighten nut by hand. Additional tightening should not be necessary, but 1/4 additional turn may be added if desired. **Do not overtighten** nut as the threads will strip and the fitting will not function properly. A proper assembly will not show the insertion mark extending beyond the nut. If the insertion mark is visible, then steps 1 thru 4 must be repeated.

### Step 5.

When using clear vinyl tubing or urethane tubing, it is necessary to use a **TS** tube support. Disassemble the fitting and place the nut, grab ring, spacer and tube support, in that order on the tube. Locate the grab ring at the insertion mark as shown. Seat the O-ring in the body, then proceed with Step 4.

**Note:** Provide adequate fail-safe mechanisms such as leakage detection sensors, automatic shut-off controls or other industry and code appropriate fail-safe devices in the design of your water-handling appliance to protect against personal injury and property damage.

Plastic fittings containing an o-ring that are used in water applications should be replaced at least every five years or more frequently depending on the environment and severity of the application.



# John Guest Super Speedfit Fittings

## How Super Speedfit Works

To make a connection, the tube is simply pushed in by hand; the unique patented John Guest collet locking system then holds the tube firmly in place without deforming it or restricting flow.

## Materials of construction

**Super Speedfit** fittings are made up of three components:

**Bodies** are produced in an acetal copolymer or polypropylene.

**'O' rings** are Nitrile rubber or EPDM.

**Collets** are produced in acetal copolymer or polypropylene with stainless steel teeth.

## How to make a connection

Cut the tube square

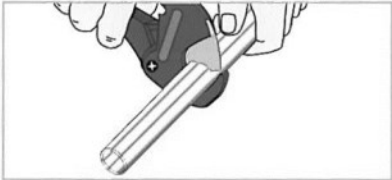

Cut the tube square and remove burrs and sharp edges. Ensure the outside diameter is free of score marks. For soft or thin walled tube we recommend the use of a tube insert

Push up to tube stop

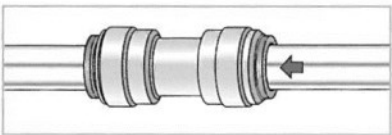

Push the tube into the fitting, to the tube stop.

Pull to check secure

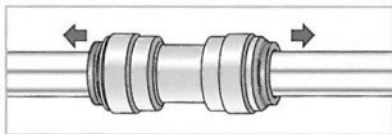

Pull on the tube to check it is secure. Test the system before use.

## Grips before it seals

'O' ring provides a leakproof seal

The Collet (gripper) has stainless steel teeth which hold the tube firmly in position while the 'O' ring provides a permanent leakproof seal.

Stainless steel teeth grips the pipe

Collet

## To disconnect

Push in collet and remove tube

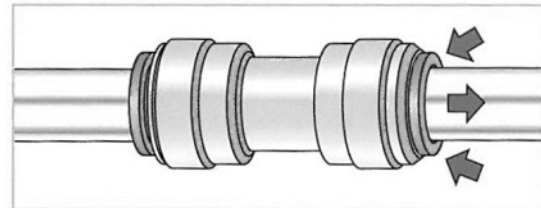

To disconnect, ensure the system is depressurized, push the collet square against the fitting. With the collet held in this position the tube can be removed.

# Spectra High Pressure Fitting Instructions

The Ventura has eight high pressure fittings, two on each cylinder on the Clark Pump, two on the pressure vessel end caps, and two 90-degree elbows on the back of the Clark Pump. As the compression fitting is tightened, it compresses a ferrule onto the stainless tubing, fixing the ferrule permanently to the tube and holding the compression nut captive.

The body of the fitting seals to the underlying component with an O-ring. On the Clark Pump cylinders and the end caps this O-ring is compressed by tightening the entire fitting. The O-rings on the 90-degree fittings on the back of the Clark Pump have captive nuts and washers, which compress the O-rings without turning the entire fitting.

If a tube fitting leaks it can sometimes be resealed by just tightening. You must use two wrenches, a 13/16-inch wrench to hold the base, and a 7/8-inch wrench to turn the compression nut. The 13/16-inch wrench will need to be thin so as not to interfere with the compression nut. If this doesn't work, disassemble the fitting, grease liberally with silicone grease (the ferrule and the threads) and re-tighten firmly.

The base O-rings should be **gently** compressed to achieve a good seal, and may be damaged by overtightening.

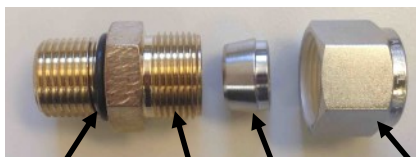

Connector O-RING

Ferrule

Stainless Fitting Hex Nut

Nickel-Bronze High Pressure Straight Fitting



Nickel-Bronze High Pressure Elbow

# Ventura Wiring

Route a pair of heavy wires from a properly-sized fuse or breaker on main DC electrical panel to the feed pump module. Refer to wire size guides below. **Wire length is the sum of the length of the Positive and Negative wires together.**

**Example:** 7 feet of duplex wire (two wires in a sheath) is needed to connect the DC electrical panel to the feed pump module. In order to figure out what type of wire you need:  $7 + 7 = 14$ . Since 14 is less than 15 you would use: #10 Gauge (6mm) to 15 feet (4.5 M).

Connect wires using supplied terminal block, then seal the connectors. The switch on the feed pump will facilitate maintenance. You may also wish to switch the system remotely, as from a switch or breaker on the main distribution panel. *Voltage drop will impair performance of the system.*

## Wire Size Guide for 12 VDC Ventura

**Protect with 15 Amp fuse or circuit breaker**

# 10 Gauge (6mm<sup>2</sup>) to 15 feet (4.5M)

# 8 Gauge (10mm<sup>2</sup>) to 25 feet (7.5M)

#6 Gauge (16mm<sup>2</sup>) to 35 feet (10.6M)

## Wire Size Guide for the 24 VDC Ventura

**Protect with 7.5 Amp fuse or circuit breaker**

#10 Gauge (6mm<sup>2</sup>) to 25 feet (7.6M)

#8 Gauge (10mm<sup>2</sup>) to 35 feet (10.6M)

### Feed Pump wiring:

**Red** is positive.

**Black/Yellow** is ground.

**Cooling Fan** connects in parallel with the feed pump. Pre-wired at the factory.

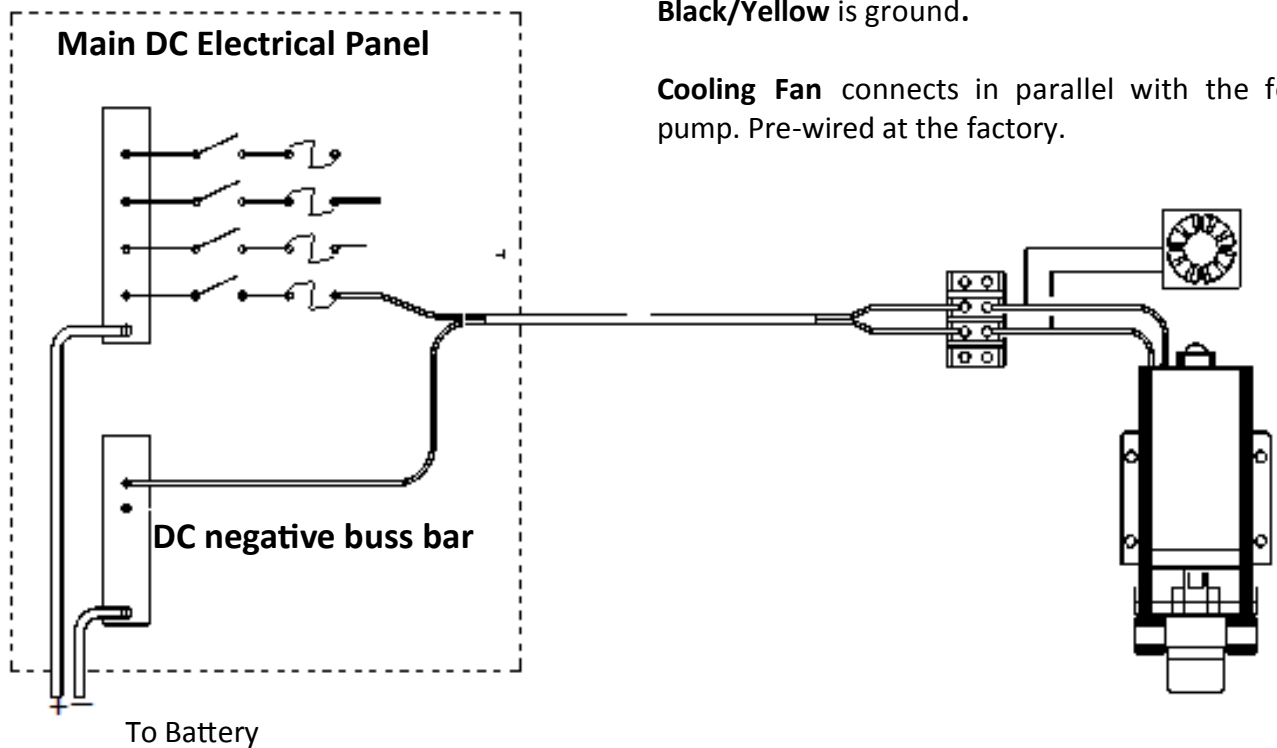



## **Optional Z-Ion Protection System**

The Z-Ion, developed by Spectra, protects the entire system from fouling for extended periods without fresh water flushing or storage chemicals (pickling).

The Z-Ion achieves this end by introducing a stream of metallic ions into the fresh water flush water, thus flooding the entire system with ions that prevent biological growth for up to thirty days. If you are going to let your system sit idle for longer than thirty days, you will still need to treat it with SC-1 storage chemical or propylene glycol.

The Z-Ion will not prevent freezing, so in freezing climates pickling with propylene glycol is still required. Even with the Z-Ion there may still be cases when you need to pickle your system with SC-1 storage chemical or propylene glycol, so we recommend you carry one of these products at all times.

If your system was ordered with the Z-Ion, it will require only some basic wiring and commissioning, laid out in the following pages.

If you didn't order your system with the Z-Ion, it can be retrofitted to any Spectra system.

## Z-Ion Installation

If you did not order your Ventura system with the optional Z-Ion you may disregard this section of the manual.

If you ordered your Ventura with a Z-Ion, the feed pump module will come with the Z-Ion installed in place of the standard fresh water flush module, as shown, with a separate Z-Ion electronic control box:

### Feed Pump Module:

Hose barb connection to house pressure water system, with valve

Generator bowl with charcoal filter.



Fresh water flush valve: manually opened at the start of the cycle and closed at the end.

Generator bowl connector

System electrical bus bar: Z-Ion will connect here (or any convenient connection to ship's power).

### Control Box:

Z-Ion control box: Mount in a visible location near the feed pump module.

On/Off switch

Connector for generator bowl

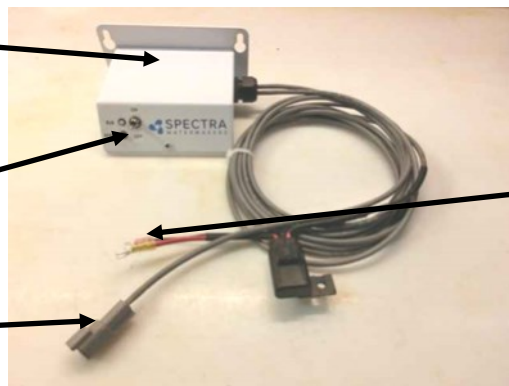

Z-Ion power cable with in-line fuse: Connect to the system electrical bus or other source of ship's power.

## Z-Ion Installation continued...

### Z-Ion Power Connections

Turn the main DC breaker off or remove the main power fuse to the watermaker.

Locate the DC Bus Bar for the watermaker (or any other DC power source), as shown below. Connect the DC power leads from the Z-Ion Control Box to the Incoming DC Bus Bar.

- Pay attention to polarity!
- Connect Red (fuse) to DC +
- Yellow (or black) to DC -
- Replace protective cover

**Z-Ion Fuse holder:** Install in a dry location with easy access.

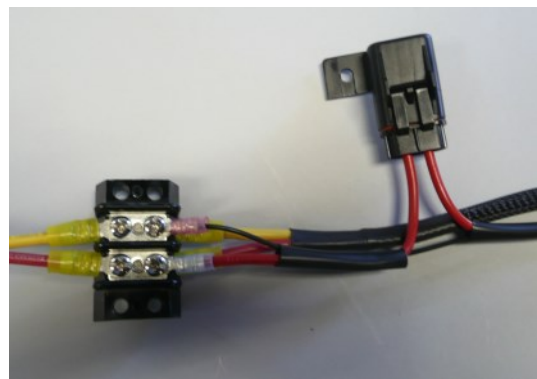
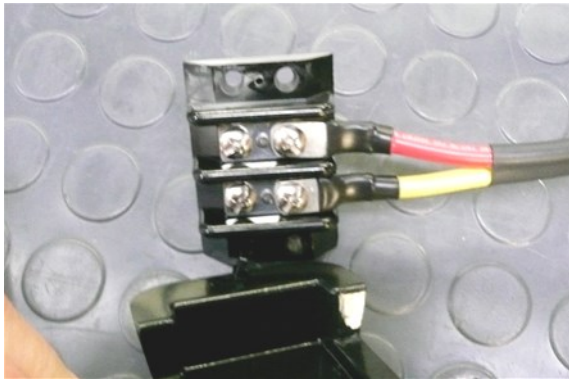

### Connection from generator bowl to control box:

The pigtail from the control box has a water-tight connector, which connects to the pigtail from the generator bowl:



## Z-Ion Operation

The Z-Ion should be energized at all times, but will only consume power when operating. Upon initial power-up the LED will flash red/green and then will turn solid green.

Follow the instructions for Normal Operation and Fresh Water Flush. For treatment with the Z-Ion, the process is identical, only the Z-Ion will release silver and copper ions into the flush water when you turn on the generator with the on/off switch. Turn on the ion generator at the same time that you open the flush valve.

The operation cycle begins and the LED will flash green/amber. The cycle will continue until you turn off the ion generator or adjustable timer times out (factory set for 15 minutes).

Turn off the ion generator at same time that you close the flush valve. If you forget to turn off the ion generator, the Z-Ion will time out after 15 minutes, so no harm will be done to the unit.

If the voltage is out of range, below 10V or above 56V, the LED will flash red every two seconds and the unit will shut down.

Each fresh water flush with the Z-Ion will protect your watermaker for up to 30 days, after which the process must be repeated.

After 720 cycles the service light on the front of the control box will light up, indicating that the probes on your Z-Ion may be wearing down, and should be tested. The service light is just a reminder, and the Z-Ion will go on functioning while it is lit. For testing procedures, see the next page.

To reset the service counter, touch two magnets, at the same time, to the two red reed switches on the Z-Ion circuit board, labeled Switch 1 and Switch 2 below.

### Z-Ion Circuit Board Layout

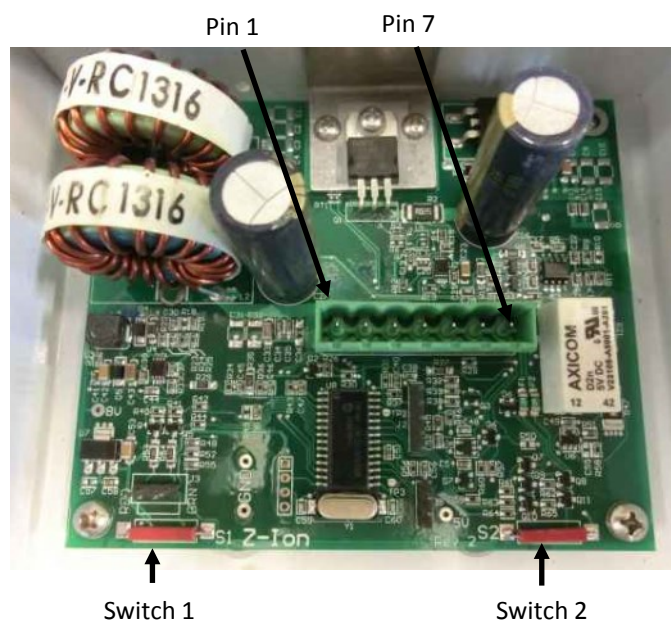

## Testing the Z-Ion

Normally no adjustment is necessary as the unit has been set up at the factory for your water-maker, however it is advisable to make sure the Z-Ion is working properly. Likewise, the following test is the only way to know if the probes on the Z-Ion need replacement.

There is no way to test for silver ions, but we can test for copper ions. The Z-Ion puts both into the flush water, and where there is one there is the other. You will need Spectra test kit (EL-ZION-TESTKIT) or a similar copper test kit for pools and spas.

Once the installation is complete and the unit is powered up, carry out a fresh water flush per the instructions. The LED on the Z-ION controller should flash as the unit cycles. Close to the end of the flush cycle, take a sample of the brine discharge. If the brine discharge thru-hull isn't accessible you will need take a sample from the brine outlet on the Clark Pump, or use the brine discharge service hose. Once you have obtained a sample, first check it with a salinity meter to make sure the salinity is below 1000 PPM. Next, use the copper test kit to make sure the flush water contains between .5 and 1 Parts Per Million of copper.

Note: A new carbon filter will sometimes absorb some of the copper ions, causing a copper test to read low. Samples should be taken after a new carbon filter has been wet for a few days.

***If the flush water does not have adequate copper content then please contact our technical support for instructions on how to adjust the system.***

Copper test kit:





# Operation





# New System Startup

Follow this procedure for starting a new system the first time, and after a system has been stored or cleaned with chemicals. Avoid running the watermaker if the vessel is in contaminated water, such as in a polluted harbor or canal. The system should be fully run tested **before** you leave port. If the location or weather prevents proper testing refer to the next page, "Testing with an Artificial Ocean."

**Warning! Damage will occur if the purge sequence is bypassed and the membrane is pressurized with storage chemical in it.**

## 1. First check that:

- Thru-hull inlet valve and brine discharge valve are open.
- All of your hose connections are tight.
- The green warning tag and washer have been removed from under the pressure relief valve.
- The pressure relief valve is open 1/2 turn.
- The sampling valve is set to the sample position.

To Sample    To Tanks

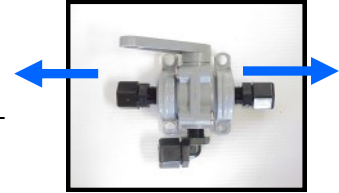

## Remove Tag and Washer!



## Open 1/2 Turn to Purge Chemicals!

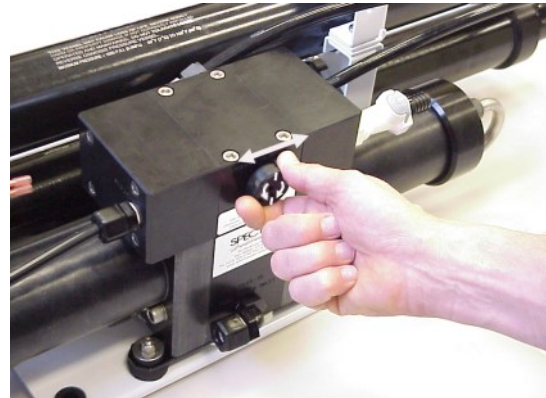

2. Turn on feed pump and check to make sure water is coming out of the brine discharge (thru-hull above water).

3. Run the system without pressure for 20 minutes (**4-6 hours if stored with propylene glycol**) to purge the storage chemicals. The flow pressure gauge should read around 20 PSI (1.2 bar). This is open flow, or static pressure.



4. Close the pressure relief valve. The pressure should rise to 60-80 PSI (4.2-5.7bar) on a Ventura 150 and 80-90 PSI (5.5-6.5 bar) on a 200T. Water should begin to flow out of the sampling tube. If the vessel is located in brackish or fresh water the pressure will be lower.

# Testing with an Artificial Ocean

If it is not possible to test run the system with the boat in the water, testing may be accomplished with an artificial ocean. You will need 1.3 lbs. of non-iodized salt (rock salt, sea salt, or aquarium salt) to make 5 gallons (605 grams of salt per 20 liters) of seawater that is about 33,000 PPM salinity (average Seawater salinity). A good rule of thumb is 1/2 cup (.12 liters or 32 grams) of salt per gallon (4 liters) of water. If a hydrometer is available, mix to a specific gravity of 1.025. Make sure the domestic water system is powered up and the boat's tank has at least 30 gallons (120 Liters) of water to purge the storage chemicals from the system. Confirm that the charcoal filter is installed, and the domestic water line is connected.

1. **Open pressure relief valve on the Clark Pump. Remove the green tag and spacer! Leave the Pressure relief valve open half a turn.**
2. Turn the yellow service valve on feed pump module to OFF.
3. Open the grey flush valve on the charcoal filter housing.
4. Start the feed pump (Flip metal toggle switch to ON). Let the feed pump run for 20 minutes to purge the storage chemicals.
5. Stop the feed pump (metal toggle switch to OFF) and close the grey flush valve.
6. Connect the inlet service hose to the service port on feed pump module A, then connect the brine discharge service hose to the quick disconnect fitting on Clark Pump. Refer to the photo below. Route both hoses into the 5 gallon (20 Liter) container. Turn the product sample valve to the sample position, and route the **product** into the bucket.
7. Open the grey flush valve and turn on the feed pump. Fill the container with fresh water. Stop the pump and close the grey flush valve.
8. Turn the yellow service valve to SERVICE.
9. Mix the salt to the proper proportion or use an aquarium hydrometer to adjust the salinity level.
10. Start the feed pump, allow to prime, then close the pressure relief valve. The system will build pressure and start making water, with the product and brine recombining in the container to be cycled again.
12. Run the system under pressure, checking for proper operation and leaks.

After testing the system, stop the feed pump. Remove the inlet service hose and the brine discharge hose. Turn the yellow service valve to RUN. Perform a fresh water flush. A fresh water flush will hold the system for 5 days (30 with the Z-Ion). For longer periods we recommend a storage procedure.

Valves in flush position:



- Flush Valve **OPEN**
- Service Intake **PORT**
- Service Valve **OFF**

Valves in service position:



- Flush Valve **CLOSED**
- Service Hose **ATTACHED**
- Service Valve to **SERVICE**

Open the pressure relief valve  
On Clark Pump:

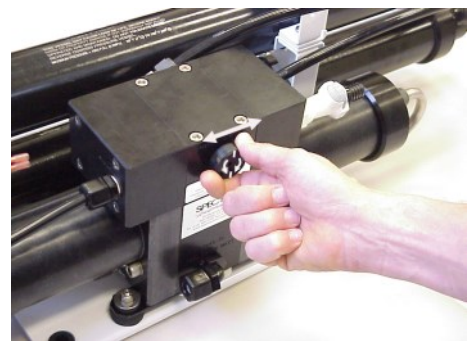

Connect the brine discharge service hose:



# Normal Operation and Fresh Water Flush

If the system has been pickled, stored, or contains cleaning compounds, use the New System Startup procedure.

**THE VENTURA 200T IS DESIGNED FOR WARM WATER USE. OPERATION IN WATER BELOW 50 DEG F (10 DEG C) MAY CAUSE HIGH OPERATING PRESSURES AND INCREASED WEAR**

1. Check that the thru-hull inlet is open.
2. Turn the product sample valve to the SAMPLE position.
3. Turn the yellow service valve on the feed pump module to RUN.
4. Start the feed pump (switch the metal toggle switch on the feed pump module to ON) and check for flow by inspecting the brine discharge and checking for pressure on your analogue gauge. If there is no flow open the pressure relief valve on the Clark Pump to prime the system and bleed the air out of the feed pump.
5. After 5 minutes check the product water with your handheld salinity tester. When it is below 750 PPM, divert the product into your tank by rotating the product sample valve handle 90 degrees.
6. Run the system until you have filled your tank or have made enough to meet your requirements.

Product Sample Valve



Analogue Gauge Panel



## Fresh Water Flush (You should fresh water flush your watermaker after every use.)

1. Turn the yellow service valve to OFF. Open the grey flush valve on filter housing at the top of the feed pump module
2. Turn the toggle switch ON and flush for 3 minutes. Pressure will drop on the gauge, which indicates that the membrane is flooded with fresh water. Turn the toggle switch OFF.
3. Return the yellow service valve to RUN. Close the grey flush valve.

You may now leave the system unattended for up to five days (30 with the Z-Ion) without further attention

Remember that you need to run the system almost a half an hour to make enough water for a flush. You may notice that the system output is higher while charging your batteries, as the machine is voltage sensitive.

## Feed pump module with valves in the "Run" Position:



## Feed pump module with valves in the "Flush" Position:

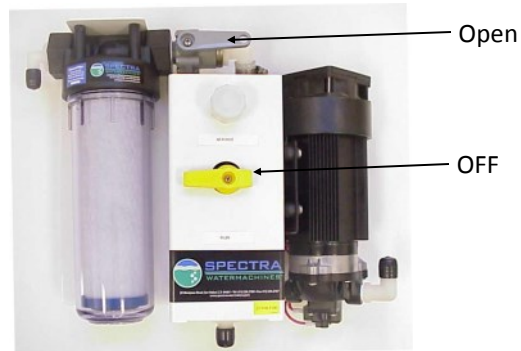

## Optimizing the Fresh Water Flush Duration

Three minutes is usually the right flush duration to ensure that sea water is thoroughly flushed out of the watermaker using the least amount of fresh water. However, due to different lengths of hose runs, different rates of flow, and different pressures in shipboard fresh water systems, the flush duration can be optimized for your boat: Your system may require more than three minutes to adequately flush the system, or you might need less time, allowing you to save more fresh water.

### **1. Check the flow rate**

The charcoal filter in the fresh water flush circuit is rated for 1.5 GPM (6 LPM). If your house pressure water system pushes more than 1.5 GPM through the charcoal filter (4.5 gallons in 3 minutes) then chlorine won't be adequately removed from the flush water. Connect the brine service hose to the Clark Pump and run it into a graduated container. Open the pressure relieve valve on the Clark Pump, open the service valve, and time the flow.

A 1.5 Gallon Per Minute flow regulator is built into the fresh water flush module, and flow of more than 1.5 GPM indicates a malfunction. Please contact the factory if you measure a flow rate of more than 1.5 GPM.

### **2. Optimize the time**

Ideally the salinity of the brine discharge will be completely fresh just as the flush cycle is completed. Using the brine discharge service hose, direct the brine discharge into a bucket. While the system is fresh water flushing, take repeated samples from the brine discharge and test it with a handheld salinity meter. When the PPM drops below 1000 you can consider the system to have been fresh water flushed, and note the elapsed time. This will be your optimum flush duration going forward.

# **Maintenance, Storage, and Troubleshooting**



# Suggested Spares

## Short term cruising, weekends, etc.:

We suggest a basic Cruise Kit A. This kit consists of six 5 micron filters and SC-1 storage chemical.

## Cruising 2 to 6 months at a time:

Two basic cruise kits, one replacement charcoal filter, one replacement feed pump head.

## Longer than 6 months:

Additional filters, Offshore Cruising Kit consisting of Clark Pump seals, O-rings, tools, and membrane cleaning chemicals. One replacement strainer screen, O-ring for strainer screen, O-rings for filter housings. Spare feed pump and/or spare feed pump diaphragm.

## Common Parts:

<b>Item</b>	<b>Part Number</b>
SC-1 STORAGE CHEMICAL	KIT-CHEM-SC1
SC-2 CLEANER	KIT-CHEM-SC2
SC-3 CLEANER	KIT-CHEM-SC3
BASIC CRUISE KIT A	KIT-BCK-A
OFFSHORE REBUILD KIT	KIT-OFFSH
5 MICRON FILTER	FT-FTC-5
CHARCOAL FILTER	FT-FTC-CC
5" STRAINER SCREEN	FT-STN-5S
OIL/WATER FILTER	FT-FTC-OW
FEED PUMP	EL-FP-12V or 24V
FEED PUMP HEAD	PL-PMP-SFPH
FEED PUMP DIAPHRAGM	EL-FP-DP
5" STRAINER O-RING	SO-STN-5SS
FILTER HOUSING O-RING	SO-FHS-10H
CHARCOAL FILTER HOUSING O-RING	SO-FHS-3PCS10

# Maintenance

## General

Periodically inspect the entire system for leakage and chafing. Repair any leaks as soon as you find them. Some crystal formation around the Clark Pump blocks is normal. Wipe down any salt encrusted areas with a damp cloth.

Watermakers are at their best when run regularly. Biological fouling in the membrane is more likely when a watermaker sits idle. A warm environment will cause more growth than a cold environment. A fresh water flush every five days will greatly reduce biological growth but may not stop it completely. You can also protect your watermaker with the optional Z-Ion system, which protects the membrane and filters from bio-fouling without the use of storage chemicals.

## The Seawater Strainer

The seawater strainer's stainless steel element should be inspected, removed, and cleaned as needed. Ensure that the thru-hull is closed before disassembly and the gasket is in place before reassembly. When the system is put into storage, remove the strainer, rinse with fresh water, and reassemble dry to impede corrosion. Check frequently during operation.

## The Pre-filter

Service the pre-filter on a regular basis. On a Ventura the pressure will drop on the remote gauge when the filter becomes dirty, if the system is installed as pictured in the plumbing schematic. Extremely dirty filters will harm system performance and may cause the feed pump to cut out from high pressure. Leaving dirty filters in the machine during long idle periods will cause biological contamination.

To service the pre-filters, turn yellow service valve on the feed pump module to OFF, open the housing, and remove the old filter. Clean out the housing bowl and reassemble the housing with a new 5 micron filter element. Leave dry until next startup. Use only Spectra-approved filters or you may void your warranty.

The filters may be cleaned several times and reused, either by hanging overboard overnight from a rocking boat, dragging behind your vessel underway, or by gently spraying with a hose. Drying in the sun helps remove odors. If a filter element show any evidence of damage or fraying, discard it. Occasionally, lightly lube the filter housing O-ring with silicone grease.

## Oil Water Separator (Optional)

For oil/water separation, install an additional filter housing with an oil removal filter *upstream* of the 5 micron filter. Service at the same time as the 5 micron filter.

## The Charcoal Fresh Water Flush Filter

Replace the charcoal filter element at least every 6 months. This filter protects the membrane by removing chlorine from the flush water. Use only a Spectra-approved replacement.



## Maintenance Continued...

### The Feed Pump and Clark Pump

The feed pump and the Clark Pump require no routine maintenance except inspection for leaks. Tighten any hose clamps or fittings that show signs of leakage. The high pressure fittings threaded into the Clark Pump have O-ring seals with a straight thread. These should never leak and should never be over-tightened. If one of the tube nuts starts to leak, it can be un-threaded, sealed with a bit of silicone grease or oil, and tightened with two wrenches very tightly.

### The Membrane

Always perform a flow test before cleaning your membrane. Cleaning with chemicals shortens the lifespan of membranes, so only clean if you are certain it is warranted. The leading cause of fouling is biological growth that forms when the system is left unused without flushing or pickling. Fouling from mineral scaling can happen during operation under certain seawater conditions, and from rust. Monitor the product salinity and feed pressure for higher than normal readings, and take environmental conditions into consideration:

- Cold feed water or clogged filters can cause high pressure.
- Low product flow is usually due to low voltage, a worn feed pump, or worn Clark Pump.

**Test to see if biological growth has occurred:** Before running the system, remove the pre-filter and examine its condition. If the filter housing is full of smelly, discolored water, the system was not properly stored. Install clean pre-filters.

Next check the membrane. Attach the brine discharge service hose and lead it to a bucket. Open the pressure relief valve half a turn, and run the system for 30 seconds (metal toggle switch on feed pump module). Examine the brine water: If it is discolored and smells bad, perform an SC-2 cleaning with unchlorinated water before running the system pressurized. If the brine is fairly clean, follow the “new start up procedure” and run normally. Check for performance. Clean the membranes **only if** performance is reduced.

See the **Cleaning Procedure** for complete instructions.

## INTRODUCTION TO SPECTRA CHEMICALS

We use four types of chemicals: SC-1, SC-2, SC-3, and propylene glycol antifreeze. SC-1 and propylene glycol are for system storage, while SC-2 and SC-3 are for membrane cleaning.

**Note: Never use any chemicals with the system pressurized!** Always open the pressure relief valve 1/2 turn. Always follow the instructions for purging the chemicals as shown in the New System Startup section.

**Storage:** SC-1 prevents biological growth when your system sits idle. It should not be used as a cleaning chemical, nor will it protect your system from freezing. An 8 oz. jar of SC-1 is mixed with three gallons of product or dechlorinated fresh water and circulated through the system for 10 minutes. This treatment will protect the system for six months, after which the SC-1 treatment must be repeated. To use SC-1, follow the instructions for **Storage Procedure**.

Spectra systems should be stored with propylene glycol if freezing is likely to occur. Propylene glycol can be used instead of Spectra SC-1 storage chemical for storage in any climate, and treatment is effective for one year. Propylene glycol is a food-grade antifreeze used to winterize RV's, boats, and cabins. Do not use ethylene glycol automotive antifreeze, which is toxic and will damage the system.

The propylene glycol formulations sold in marine and RV stores are usually diluted with water. The water remaining in the watermaker before the storage procedure will further dilute the antifreeze, reducing the microbial protection and increasing the temperature at which the mixture will freeze.

Antifreeze labeled "Minus Fifty" is a 25% solution and will begin to form an icy slush at about +15Degrees F (-10C) and will only provide burst protection to about Zero F (-18C). After a further 50% percent dilution by water remaining in the watermaker, "Minus Fifty" antifreeze will only protect from bursting down to about +25F (-4C). Therefore if low temperature freezing protection is required a 60% or stronger antifreeze should be used. 60% solutions are labeled "Minus 100" and will provide burst protection to -15F (-27C) even after a fifty percent dilution with residual water. "Minus 200" formulations are pure propylene glycol.

Complete microbial protection requires a 25% solution of propylene glycol, so care must be taken that the solution remaining in the watermaker during long term storage is at least 25%, even if freeze protection is not required. For these reasons Spectra recommends that all pickling be carried out with a 60% or greater concentration.

See **Winterizing with Propylene Glycol**.

## Introduction to Spectra Chemicals continued...

Propylene glycol can be difficult to flush from a membrane, especially after extended storage periods. This results in high salinity water (high PPM) and residual flavor in the product water. We recommend flushing the system WITH THE PRESSURE RELIEF VALVE OPEN for 4-6 hours after storage with propylene glycol—the longer the better. If, after extended flushing, you still experience low product water quality, cleaning with SC-2 usually removes all traces of propylene glycol and returns the salinity to the level it was before storage with propylene glycol. See the **Cleaning Procedure**.

**Note: Do not use metasodium-bisulfate, Citric Acid, or any other storage chemical not supplied by Spectra.** These chemicals, used to store other watermaker brands, are very acidic and will damage the Clark Pump and void the warranty.

**Cleaners:** Cleaning can be detrimental to the membrane and shorten its life. Avoid unnecessary cleaning. Avoid cleaning as a diagnostic tool.

SC-2 is an alkaline cleaner used to remove light oil, grime, and biological growth. It is most effective if heated to 120 deg. F (49 deg. C), which is difficult on a boat. In most cases the water quality will increase in PPM (salinity) after an SC-2 cleaning. After a few hours it should recover to near the level it produced before the cleaning.

SC-3 is an acid cleaner used to remove mineral and scale deposits. In most cases this is used first and if there is no improvement, go on to the SC-2. SC-3 will in most cases lower the product PPM and overall pressures. Scaling is a slow process that may take several months or years. SC-3 is less harmful to the membrane and will almost always improve the performance of an older membrane.

For cleaning with either SC-2 or SC-3, see the **Cleaning Procedure**.

# Storage Procedure

NOTE: The Ventura contains about 2 gallons of water at any given time, so with one gallon in the bucket there will be a total of 3 gallons of solution.

1. Perform a fresh water flush (Refer to Normal Operation and Fresh Water Flush. Turn off the feed pump and close the grey fresh water flush valve. Leave the yellow service valve OFF.
2. Disconnect the brine discharge hose from the Clark Pump, and replace with the brine service hose from your service kit. Lead the service hose to a 5 gallon bucket.
3. Do another fresh water flush, running the feed pump until you have one gallon of fresh water in the bucket. Turn off the feed pump and close the grey fresh water flush valve.
4. Mix one 8 oz. container of SC-1 storage compound with the water in the bucket. It will not dissolve completely, which is normal, and any undissolved particles will be caught by the pre-filter.
5. Connect the service hose to the service port above the yellow valve on the feed pump module and lead the hose into the solution in the bucket. Turn the yellow service valve to SERVICE. The system will draw solution from the bucket and return it via the brine discharge hose.
6. **Make sure the pressure relief valve on the Clark pump is Open (unpressurized), 1/2 turn counter-clockwise OR THE MEMBRANE WILL BE DAMAGED.**
7. Turn on the feed pump and circulate the storage solution through the system for 10 minutes. Turn off the feed pump when finished.

## Clean Up:

1. Remove the brine service hose from the Clark Pump brine discharge, and replace the original hose that leads to the thru-hull.
2. Turn the yellow service valve back to RUN. Remove the intake service hose, and replace the cap.
3. Close the seacock, drain then clean the sea strainer and pre-filters. Reassemble dry with new filters.

Your system is now protected for the next six months.

Feed Pump Module Valves in **FLUSH** position:

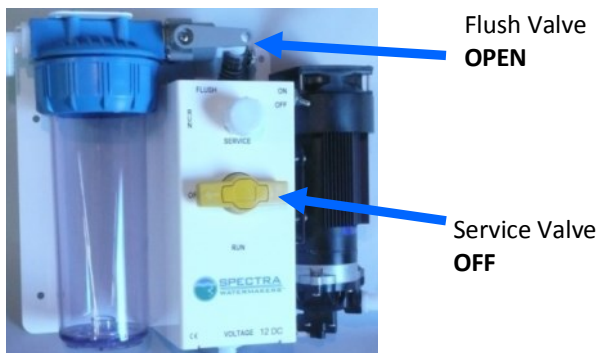

Opening the pressure relief valve on Clark Pump:

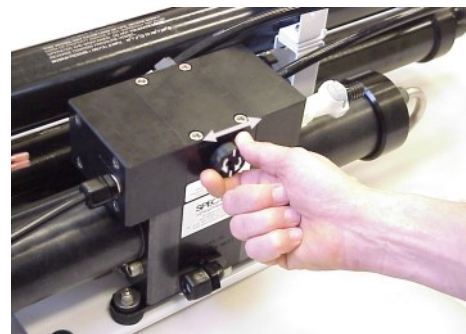

Valves in **SERVICE** position:

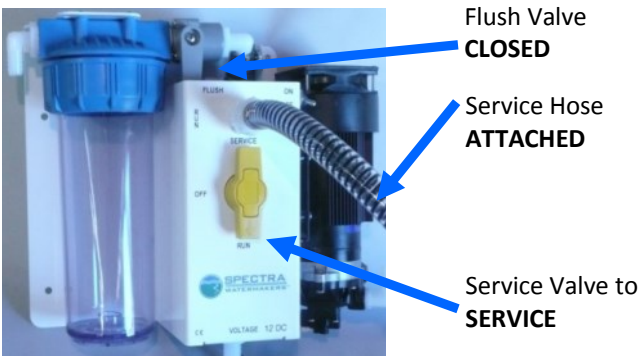

Connecting brine discharge service hose:



## Winterizing with Propylene Glycol

1. Fresh water flush the watermaker. (Refer to Normal Operation and Fresh Water Flush). Turn off the feed pump (metal toggle switch in top right corner of feed pump module). Close the grey flush valve (located on feed pump module).
2. Connect the inlet service hose to the service intake on the feed pump module, and lead it into a bucket. Connect the brine discharge service hose, and run it into a second container.
3. Turn the yellow service valve to the SERVICE position.
4. Pour 1 gallon (4L) of propylene glycol of appropriate concentration into the bucket with the intake service hose.
5. **Make sure that the pressure relief valve on the Clark Pump is OPEN a 1/2 turn, OR THE MEMBRANE WILL BE DAMAGED.**
6. Run the feed pump until about a gallon of water has flowed from the brine discharge service hose, or antifreeze appears. Propylene glycol will look slightly different, and feel more slippery, than water. Stop the pump. Add more propylene glycol to the intake bucket if necessary.
7. Lead the brine discharge service hose into the same bucket as the intake service hose. The system will now draw propylene glycol solution from the bucket with the intake service hose and return it via the brine discharge service hose.
8. Run the feed pump to circulate the antifreeze in this manner for 10 minutes.
9. Stop the feed pump. Reconnect the brine discharge hose that leads to thru-hull. Run the feed pump until the bucket is empty.
10. Close the seawater intake. Turn the yellow service valve to OFF. Drain the seawater strainer and the hose leading to the feed pump module. Disconnect the product tubing from the membrane housing and blow the water out. Empty the charcoal filter housing and flush water lines. Your watermaker is now protected from biological growth and freezing for one year.

Feed pump module valves in **FLUSH** position:

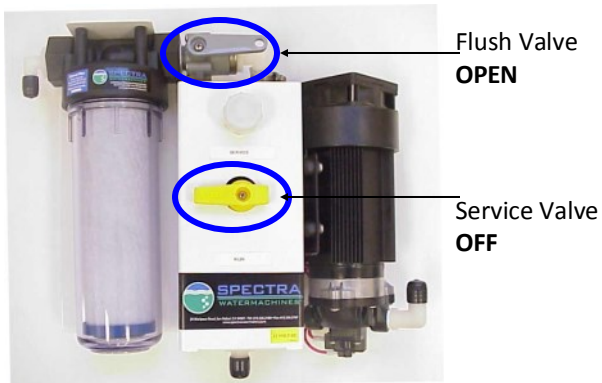

Opening the pressure relief valve:

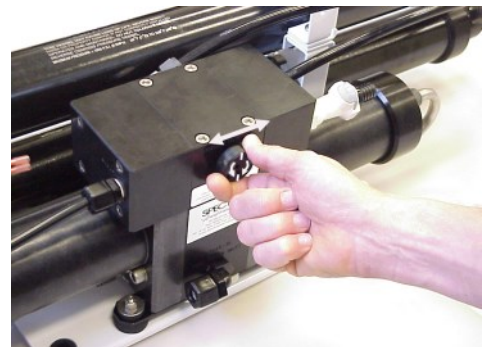

Valves in **SERVICE** position:

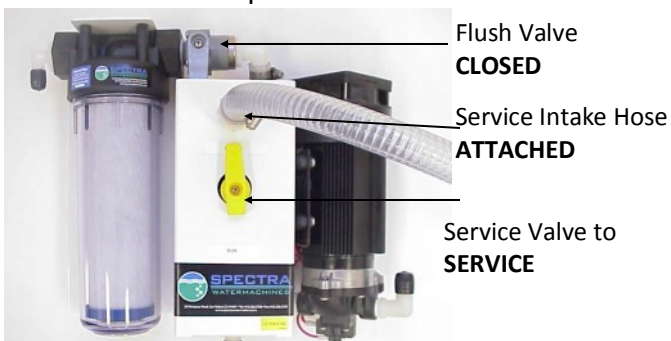

Connecting brine discharge service hose:



# Cleaning Procedures

**Note: Procedures are the same for the SC-2 and SC-3 cleaners.**

An 8 oz. jar of Spectra cleaning compound (SC-2 or SC-3) must be mixed with fresh water at a ratio of 1 container of compound to 3 gallons (12L) of unchlorinated fresh water. **An average of two gallons (7.6L) of water is already present inside a Ventura system,** and this water will be figured into the mixture.

Warm water is ideal for cleaning membranes: Use a large stainless steel pot to heat the solution to 120°F (49°C). You might have to periodically stop and reheat the solution.

1. Perform a fresh water flush (Refer to Normal Operation and Fresh Water Flush). Stop the feed pump and close the grey flush valve.
2. Connect the inlet service hose to the service intake on the feed pump module. Connect the brine discharge service hose to the quick disconnect on the Clark Pump. Lead the two hoses into a bucket. Open the grey flush valve and run the feed pump until you have one gallon (3.8L) of water in the bucket.
3. Turn off the feed pump and shut the grey fresh water flush valve.
4. Turn the yellow service valve on feed pump module to SERVICE.
5. **Make sure the pressure relief valve on the Clark Pump is OPEN 1/2 a turn (system is un-pressurized) OR THE MEMBRANE WILL BE DAMAGED.**
6. Mix the cleaning chemical with the gallon of water in the bucket.
7. Start the watermaker and circulate the chemical through the system for 45 minutes, if the solution is warm. Let the solution sit in the unit overnight if the cleaning solution is cold.
8. Stop the pump, replace the brine discharge hose, and run the pump until the bucket is empty. Stop the feed pump and turn the yellow service valve to RUN. Follow the instructions for New System Startup. **(KEEP THE PRESSURE RELIEF VALVE OPEN!)**

Feed Pump Module Valves in **flush position:**

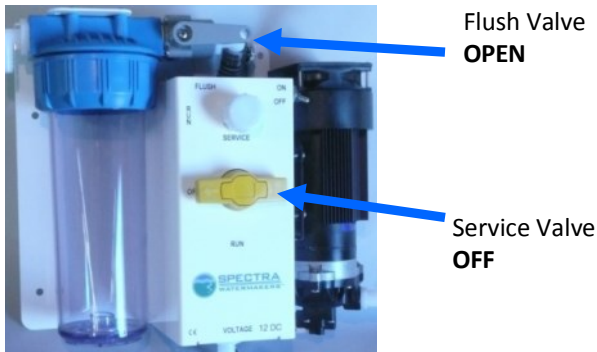

Opening the pressure relief valve On Clark Pump:

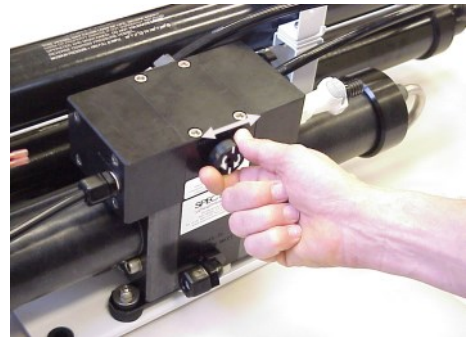

Valves in **service position:**

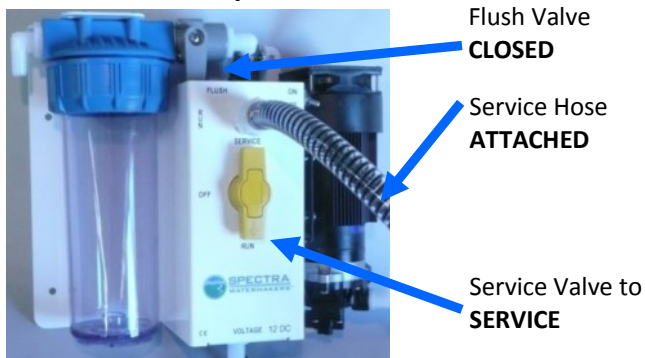

Connecting brine discharge service hose:







## Ventura Flow Test

The flow test is the most useful diagnostic test for system performance, and should be done before replacing or cleaning your membrane. Changes in production or water quality are normally caused by something **other than** the membrane, unless the system has been left unused for a long time.

Before the flow test, change all filters and clean the sea strainer. Carefully check for water or air leaks, as air in the system will cause low production and erratic salinity. Look for air bubbles in the product flow meter, feed water hoses, and brine overboard hose.

Run the system and watch the feed pressure very closely. If the feed pressure to the Clark Pump is asymmetrical from one stroke to another, this impedes performance. A difference of a few PSI is acceptable, but anything over that is an issue. If the pump is asymmetrical, Clark Pump repairs should be done before continuing with these tests.

If no asymmetry is noted, continue with this test.

Make sure the ShurFlo overpressure cutout switch (PL-PMP-SFPH) is set to 125 PSI. With the pump running, close the brine discharge thru-hull or kink the brine discharge hose. The feed pressure should rise to 125 PSI, then the pump should shut off. If the pump shuts off at a lower pressure see Adjust ShurFlo Pressure Switch.

You will need a graduated bucket, either a graduated pitcher or large measuring cup, and a stopwatch. Log the voltage at the feed pump at the same time. Confirm at least 12.5 Volts at the feed pump on 12-Volt DC systems; 25 volts on 24-Volt DC systems.

Take two measurements and compare them with the table on the following page. The first measurement is the product flow alone. The second is the product flow combined with the brine discharge flow to get the total flow or feed flow. You may take these measurements by two methods:

1. Time the product flow into a graduated pitcher, then divert both the product flow and brine discharge together into a bucket, timing them to measure total flow.

OR

2. Divert the product flow into the pitcher while diverting the brine discharge into the bucket. Time the flow of both at the same time. After calculating the product flow, pour the pitcher of product into the bucket of brine to measure total flow.

The ratio of product flow to total flow gives us our recovery rate, as a percentage. If the percentage is below the minimum it indicates an internal leak in the Clark Pump.

**1. Product Flow:** Product flow is expressed in Gallons Per Hour (GPH) or Liters Per Hour (LPH), by this equation:

$$3600 \div \text{time in seconds} \times \text{quantity of water in gallons or liters} = \text{GPH or LPH}$$

There are 3600 seconds in an hour.

Example: It took 3 minutes and 35 seconds to collect 1 gallon of product water.

$$3600 \div 215 \times 1 = \mathbf{16.74 \text{ GPH}}$$
 (3 minutes, 35 seconds is 215 seconds)

Example: It took 2 minutes and 25 seconds to collect 2.5 liters of product water.

$$3600 \div 145 \times 2.5 = \mathbf{62.07 \text{ LPH}}$$
 (2 minutes, 25 seconds is 145 seconds)

**2. Total Flow or Feed Flow:** Feed flow or total flow (brine + product) is expressed in Gallons Per Minute (GPM) or Liters Per Minute (LPM) , by this equation:

$$60 \div \text{time in seconds} \times \text{quantity of water in gallons or liters} = \text{GPM or LPM}$$

Example: It took 1 minute and thirty-seven seconds to collect 5 gallons of total flow.

$$60 \div 97 \times 5 = \mathbf{3.09 \text{ GPM}}$$
 (1 minute, 37 seconds is 97 seconds)

Example: It took 53 seconds to collect 12 liters of total flow.

$$60 \div 53 \times 12 = \mathbf{13.58 \text{ LPM}}$$

**3. Recovery Rate:** Product Flow  $\div$  Total Flow = Recovery Rate %

Example:  $\frac{6.5 \text{ GPH product flow}}{1.7 \text{ GPM total flow} \times 60} = \mathbf{.063 \text{ or } 6.3\%}$

(you must first multiply total flow by 60 to convert from GPM to GPH)

System	Feed		Static * Pressure	Feed Flow				Product Flow			
	Pressure			Normal Flow		MIN	MIN	Normal Flow		MIN	MIN
	PSI	bar	PSI	GPM	LPM	GPM	LPM	GPH	LPH	GPH	LPH
Ventura	60-70	4.2-5	10 to 15	1.7	6.4	1.65	6.2	6.5	24.6	5.7	21.5
VT 200	80-90	5.6-6.3	20 to 25	1.7	6.4	1.6	6	8.3	31.4	7.7	29.1

**\*pressure relief valve open ½ turn**

In order to make good quality product water, you need the proper amount of feed water flow, as in the table above. The recovery rate should be 6.5% (minimum 5.5%) of total flow for a Ventura 150, and 9% (minimum 8%) of total flow for a Ventura 200T. If the recovery rate is low, you may have an internal leak in the Clark Pump.

For every  $\frac{1}{10}$ <sup>th</sup> of a GPM feed water flow loss, we will lose about  $\frac{1}{2}$  gallon per hour of product flow and the salinity will go up 100 PPM.

Low feed flow combined with low system pressures is most frequently caused by a worn Shurflo pump head (PL-PMP-SFPH).



## Troubleshooting Ventura Systems

Symptom	Cause	Remedy
Feed Pump runs but no pressure.	Feed Pump air locked	Open pressure relief valve to bleed the air then close to start.
	Pressure relief valve open	Close valve.
Feed Pump starts but shuts down on high pressure.	Prefilter excessively clogged.	Change filter.
	Closed valve or blockage in flow.	Check flow path for closed valve or kink in hose.
Low Water Production High Amperage High Feed Pressure	Strainer or pre-filter clogged.	Service pre-filter and strainer.
Low Water Production, Low Feed Pressure.	Pressure Relief valve partially open.	Close Valve Check flow: <b>Should be 1.6 GPM</b>
	Worn Pump head	Replace Pump Head.
Water Production normal but High Feed Pressure, High Amperage.	Cold seawater temperature	Normal condition
	Fouled membrane	Clean membrane
Water Production normal but Lower Pressure, Lower amperage	Warm sea water or brackish water.	Normal Condition.
Asymmetrical pressure and flow readings between pump shifts	Check valve leaking	Contact Dealer or see the Clark Pump repair manual.
	Failed annular ring.	
	Shaft Seal leaking.	
Pump runs intermittently, cycling on/off	Overpressure switch on Shurflo pump opening	Adjust or replace switch
Feed pump runs with loud noise	Intake blocked Air in system	Check thru-hull valve Check sea strainer for leaks Check fresh water flush module for leaks Re-prime system (restart)

# Technical Bulletins

The following pages include Spectra's most commonly-used technical bulletins, addressing tests, adjustments, troubleshooting, and common points of confusion.

## DWYER FLOW METER SERVICE

The mechanical flow meter, PL-FMT-10 (10 GPH range) or PL-FMT-20 (20 GPH range) can be opened for cleaning if it becomes difficult to read or if the little ball gets stuck.

The flow meter will come completely apart for cleaning. First remove the meter from the panel. Remove the four small screws that hold the stainless steel bracket in place. Carefully pry off the bracket. On the very top of the meter is a clear plastic slide-off cover over an Allen screw. Use a flat bladed screwdriver to push the cover off. Holding the meter upright, remove the Allen screw with a ¼" Allen wrench. Invert the flow meter and catch the ball as it falls out. You can use tooth paste or plastic window polish to polish the inside using a small bottle brush. Clean the ball and give it a few coats of wax. If the O-rings are damaged or the unit has been leaking, install new O-rings using a little silicone grease to ease assembly. These are standard O-rings and should be available at most larger auto parts or bearing stores. Reassemble in reverse.

## ACCUMULATOR PRESSURE

Your Spectra watermaker is supplied with a pressure accumulator tank (PL-ACC-TK), which should be installed in the feed water line between the pre-filters and the Clark Pump.

The purpose of the feed line accumulator is to reduce the spikes in the feed pressure caused by the cycling of the Clark Pump. If the accumulator is not properly charged it can lead to problems with the Shurflo Pump pressure cutout switch. The accumulator has a Schrader air valve, like a car tire, which allows the internal air bladder of the accumulator to be pre-charged. The accumulator should be pumped up to about 65 psi (4.5 bar) for best results. Add air using a tire pump or air compressor. You can experiment with the exact pressure that will give the best pulsation dampening on your installation.

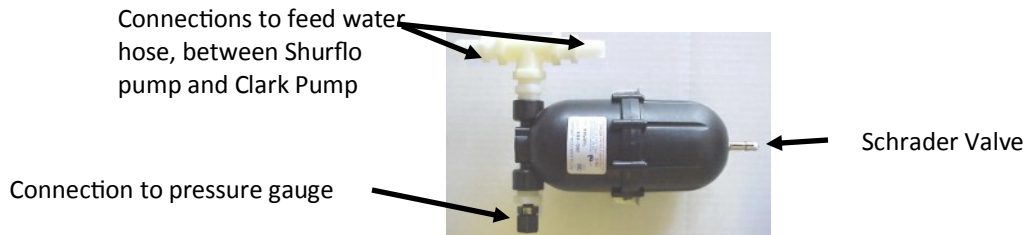

## PRE-FILTERS

A Ventura system uses two different filters to prevent damaging foreign materials from entering the system. A single 5 micron filter cleans the feed water of abrasive materials while the system is in operation; an additional carbon filter prevents the entrance of chlorine during fresh water flushing.

During normal operation, the feed water is filtered in two stages. First it passes through a fine mesh metal sea strainer, which protects the feed pump from foreign materials and sea creatures. After passing through the feed pump, the feed water passes the filter housing containing the 5 micron element, removing very fine particles that could damage the Clark Pump and shorten membrane life.

Replacement schedules will vary widely depending on how and where the system is used. If large amounts of feed water are run through the system over a relatively short period of time in biologically fertile near-shore waters, the pre-filter will plug up, water production and quality will drop, and the system pressure will change dramatically. If the pressure gauge was installed after the pre-filters, as pictured in the plumbing schematic, the pressure will decrease as the pre-filter becomes more clogged.

When operated for only an hour or two a day in inland or near-shore waters, the trapped plankton will begin to decay in the filter long before it plugs up. The decaying plankton and bacteria will cause a rotten egg smell in the product water. This decay will set in overnight in tropical waters, or after a week or two in higher latitudes. In crystal clear blue water conditions, the filters may need to be cleaned much less frequently.

If handled gently and changed regularly before they get too smelly, filters can be cleaned and reused several times.

To ensure that filter elements fit properly, they should be purchased from factory authorized dealers. Our filter element part number is FT-FTC-XX. The last digits indicate the micron rating, e.g. FT-FTC-5 is for a 5 micron element:



## CHARCOAL FILTERS

The charcoal filter element (FT-FTC-CC) removes chlorine from the fresh water flush water supply. The RO membrane can only handle small amounts of chlorine without permanent damage. If the fresh water flush water contains chlorine, the membrane will be exposed to it for days and will produce high salinity water.

The charcoal filter used for the fresh water flush system will not plug up unless you have very dirty domestic water in your boat's supply tank. About six months after installation the charcoal filter element will lose its effectiveness and must be replaced. This is purely a function of time, not usage.

The charcoal filter we supply removes 99.7% of the chlorine. Beware when buying other charcoal filters. If they don't specify the percentage of chlorine removed, don't use them. Cheap ones may remove only 60% or 70%. Also, there are aftermarket filters which are very close to, but not exactly the same dimensions, and will not seal properly in the housing. If you skimp on the charcoal filter you risk damaging a \$600.00 membrane on the first flush. The other factor is the flow rate that the filter can handle. Because the chlorine is adsorbed by the charcoal, it must remain in contact with the charcoal for a sufficient period of time for all of the chlorine molecules to be captured. The filters we use can handle 1.5 gallons (6 liters) per minute flow, and are good for 3000 gallons (12,000 liters) at 1.5 GPM, or six months, whichever comes first. Regardless of the flow, the charcoal loses its effectiveness after six months.



Charcoal filter, Spectra part number FT-FTC-CC

## SHURFLO PUMP WON'T RUN

If the pump has power to it but the pump won't run, first check the pressure switch. The pressure switch (EL-FP-PS) is located on the wet end of the pump and has two red wires plugged into it. Jump the two red wires together and see if the pump runs. You can safely run the system with the pressure switch jumped, just keep an eye on the pressure gauge and don't let system pressure exceed 110 PSI. Replace the switch when a spare is available. The pressure switch should never open unless there is a problem with the system or it is incorrectly adjusted. Check the accumulator pressure, the operating feed pressure, and the switch cut-out setting.

If the pump will not run with the pressure switch jumped then it is most likely a problem with the brushes or overheat protection switch inside the motor. The motor will come completely apart by removing the two screws on the end of the motor. Remove the rear cover and paper insulator. Pull out the plastic brush holder. The thermal switch is located on one of the brush leads. With an ohmmeter, check for continuity through the switch. If it is open, you can make temporary repairs by wiring around it, being careful that your new wiring doesn't chafe on the moving parts, nor resist the springs that push the brushes on to the commutator. The overheat switch is unlikely to fail unless the motor has overheated and shut down. Consider relocating the pump or improving ventilation if the overheat protection has failed.

If any corrosion is apparent the brushes may be sticking. Once apart clean all the carbon dust from all the parts. Clean the commutator with light sandpaper. Make sure to clean the small grooves on the commutator with a small sharp tool to remove the carbon in between the segments. Adjust the springs on the brush holders so the brushes slide smoothly in and out. If the bearings are rough and binding, remove the rubber dust cover and clean the best you can, grease them, and work them free by hand. Don't service the bearing unless absolutely necessary. Reassemble in reverse order. You can hold the carbon brushes back with paper clips inserted through the slots in the brush holder so they don't hang up on the bearing during assembly. Make sure the corrugated bearing shim doesn't push out, if it does, push it back into place.

## ADJUST SHURFLO PRESSURE SWITCH

Shurflo feed pumps are equipped with a high pressure cutout switch (EL-FP-PS). This is the small black unit on the end of the wet end of the pump head (PL-PMP-SFPH) where the two red wires connect. If the pressure switch is not properly adjusted the pump may cut out each time the Clark pump cycles and the feed pressure spikes. When this happens the production will drop and salinity will increase. The points in the switch will fail quickly if set too low because of the constant arcing each time the Clark Pump shifts.

On the very center of the switch is a small 5/64" Allen screw. While running the system close the brine discharge seacock or kink the discharge hose, to block the flow. Watch the pressure gauge and adjust the pressure switch to shut off at 125 psi. Turn the Allen screw clockwise to increase the cut off set point.

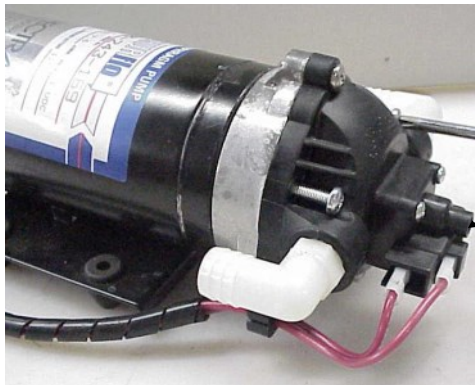

Pressure Switch  
Adjusting Screw

## Poor Product Water Quality

With any product water quality issue, you must ensure accurate calibration if you are using a salinity meter. For general quality evaluation, your taste is always good enough.

Membranes are not an exact science and two identical systems can have different product quality. World health standards deem water of up to 1000 PPM of total dissolved solids acceptable for drinking consumption. We consider anything below 750 PPM acceptable but not ideal, and anything below 500 PPM excellent. Factors that could affect water quality are addressed below.

**LOW SYSTEM FLOW OR PRESSURE** will equate to lower product quality (higher PPM).

Ventura systems, which have a higher feed to output pressure ratio (See nominal pressures under Flow Test), as well as a higher feed flow/membrane area ratio, will produce water in the 150-300 PPM range.

**DAMAGE TO THE MEMBRANE** by chlorine contamination. Flushing the system with chlorinated water will irreparably damage the membrane. Charcoal filters are used to adsorb any chlorine which might be present in flush water. They must be of proper specification to be suitable. There is no test for chlorine damage except the process of elimination of other causes.

**DIRTY OR SCALED** membranes. A dirty (foreign material), scaled (mineral deposits), or contaminated (bacterial growth) membrane can result in poor water quality and abnormal operating pressures. If operating pressures are above normal, then cleaning is indicated. If the system pressures are within normal operating range, cleaning may have little result. Avoid cleaning as a diagnostic tool. Low water quality after storage with propylene glycol can usually be remedied by extended flushing or an SC-2 cleaning.

**MECHANICAL LEAKAGE** within the membrane pressure vessel. This is an unlikely but possible cause of poor water quality. A pinched or damaged O-ring within the pressure vessel, a scratch on the product tube on the membrane, a scratch within one of the end caps, or a seal fouled by contamination could allow sea water into the product water.

If system flow (product plus brine) is 1.5 GPM or above, the membrane is clean, the product flows are consistent with the system flow and the water quality is still not acceptable, then replacement of the membrane is indicated.

# Part Numbers

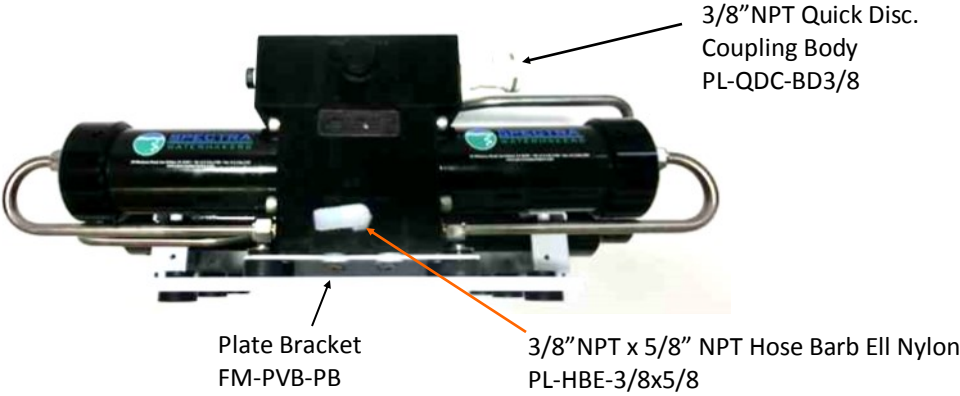

Pump to Pressure Vessel  
Upper SS Tube:  
PL-TB-HP-HPTVUS

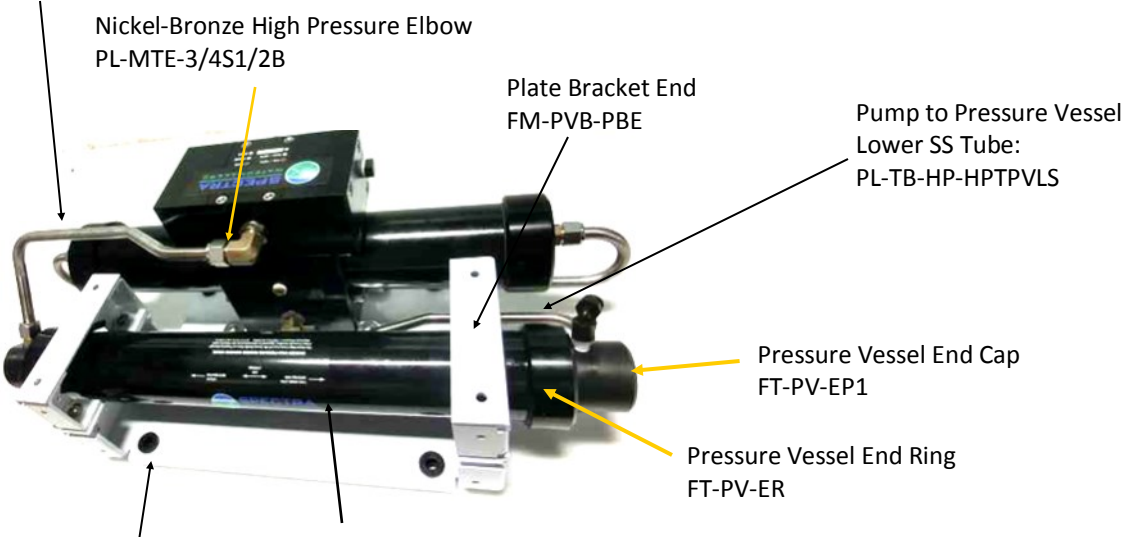

Rubber Mount  
HD-RBP-RM  
Plastic Spacer  
HD-SPN-MKINS

20-Inch Hi Rejection Membrane  
FT-MB-20F

Nickel-Bronze High Pressure Straight Fitting  
SUB-MTS-3/8X1/2

3/4" -16 Straight Thread  
O-RING  
SO-FT-STF

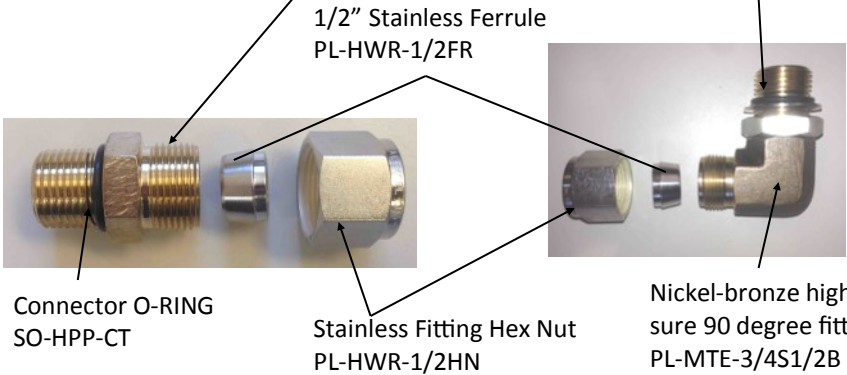



## Part Numbers continued...

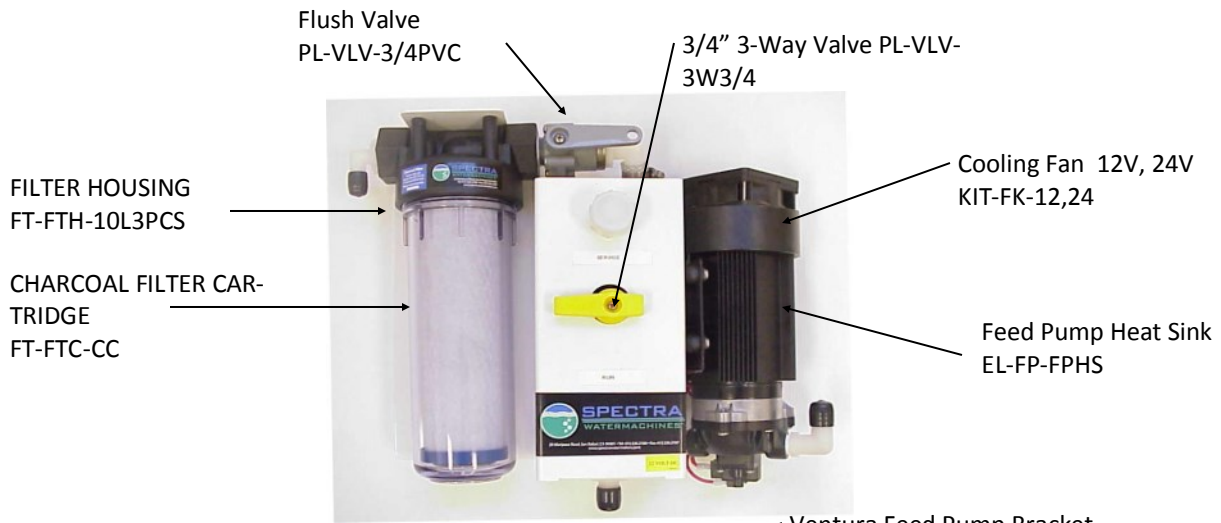

Ventura Feed Pump Bracket  
FM-VT-ITM

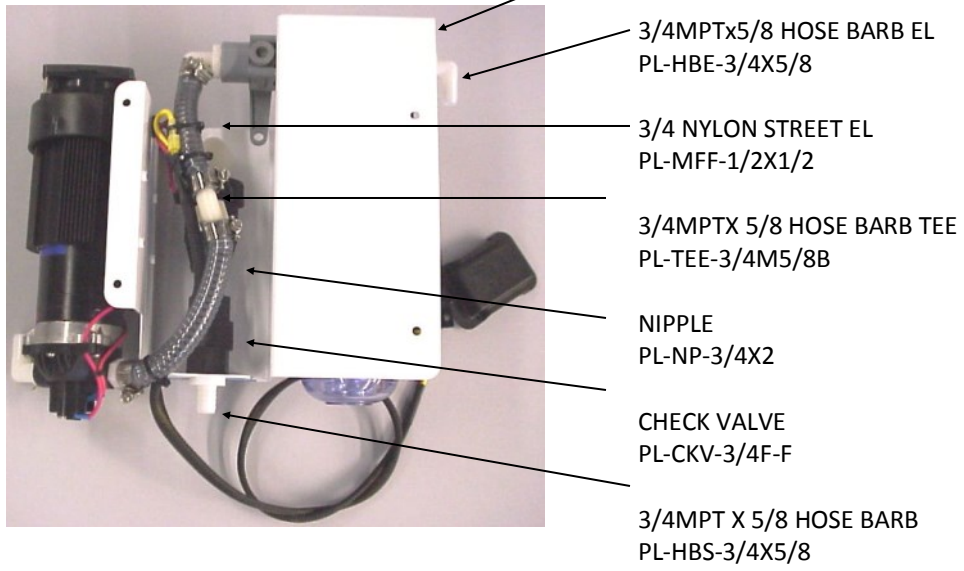

Pump Head Assembly W/Press. Switch  
PL-PMP-SFPH

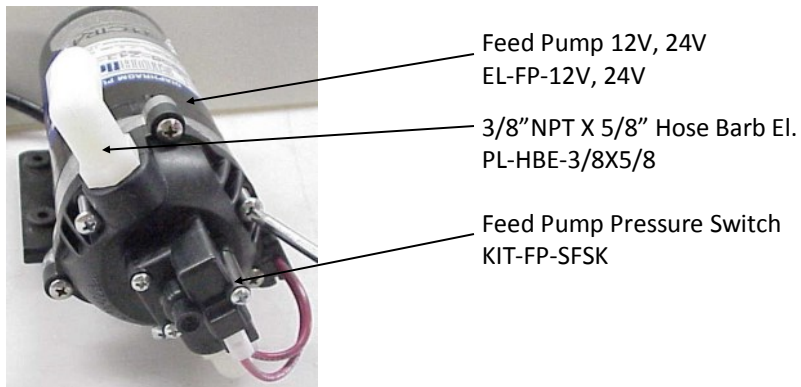
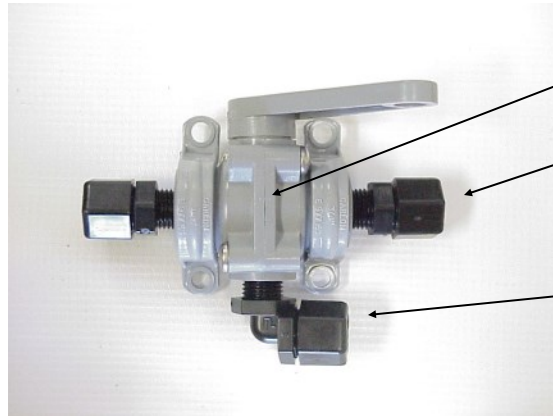

Fig 2

Fig 3

## Part Numbers continued...



PRODUCT WATER SAM-  
PLING VALVE  
PL-VLV-3W1/4

1/4 TUBE X 1/4 MPT  
STRAIGHT FITTING  
PL-MTS-1/4X1/4P

1/4 TUBE X 1/4 MPT EL  
PL- MTE-1/4X1/4P

ACCUMULATOR  
PL-ACC-TK



1/2MPT X 5/8 HOSE  
BARB PL-HBS-1/2X5/8

1/2" TEE  
PL-TEE-1/2FN

1/2" NIPPLE  
PL-NP-1/2N

1/8MPT X 1/4 TUBE EL  
PL-MTE-1/8X1/4P

PRODUCT FLOW METER  
PL-FMT-10

1/4MPT X 1/4 TUBE  
STRAIGHT FITTING  
PL-MTE-1/4X1/4

1/2 X 1/4 BUSHING  
PL-BSH-1/2X1/4N

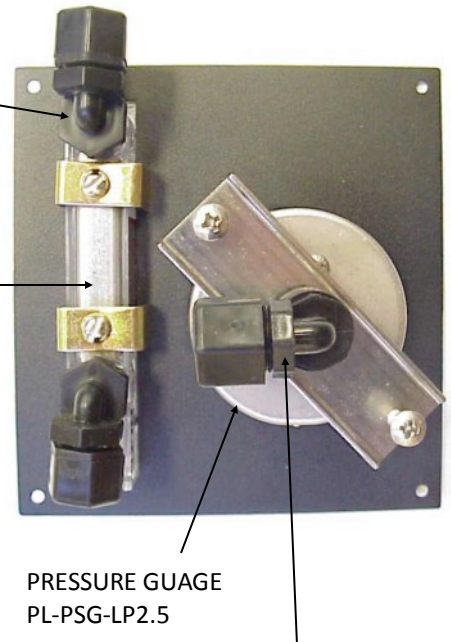

PRESSURE GUAGE  
PL-PSG-LP2.5

PREFILTER HOUSING  
FT-FTH-10H

5 MICRON FILTER CAR-  
TRIDGE  
FT-FTC-5



PRODUCT OUTLET FIT-  
TING  
PL-FTE-1/8X1/4P

NIPPLE  
PL-NP-1/8N

1/4FPT X 1/4 TUBE EL  
PL-FTE-1/4X1/4P

SEA STRAINER  
FT-STN-5

5" STRAINER O-RING  
SO-STN-5S

STRAINER SCREEN  
FT-STM-5S

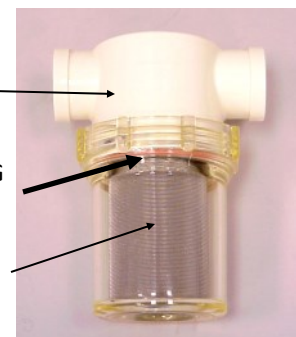

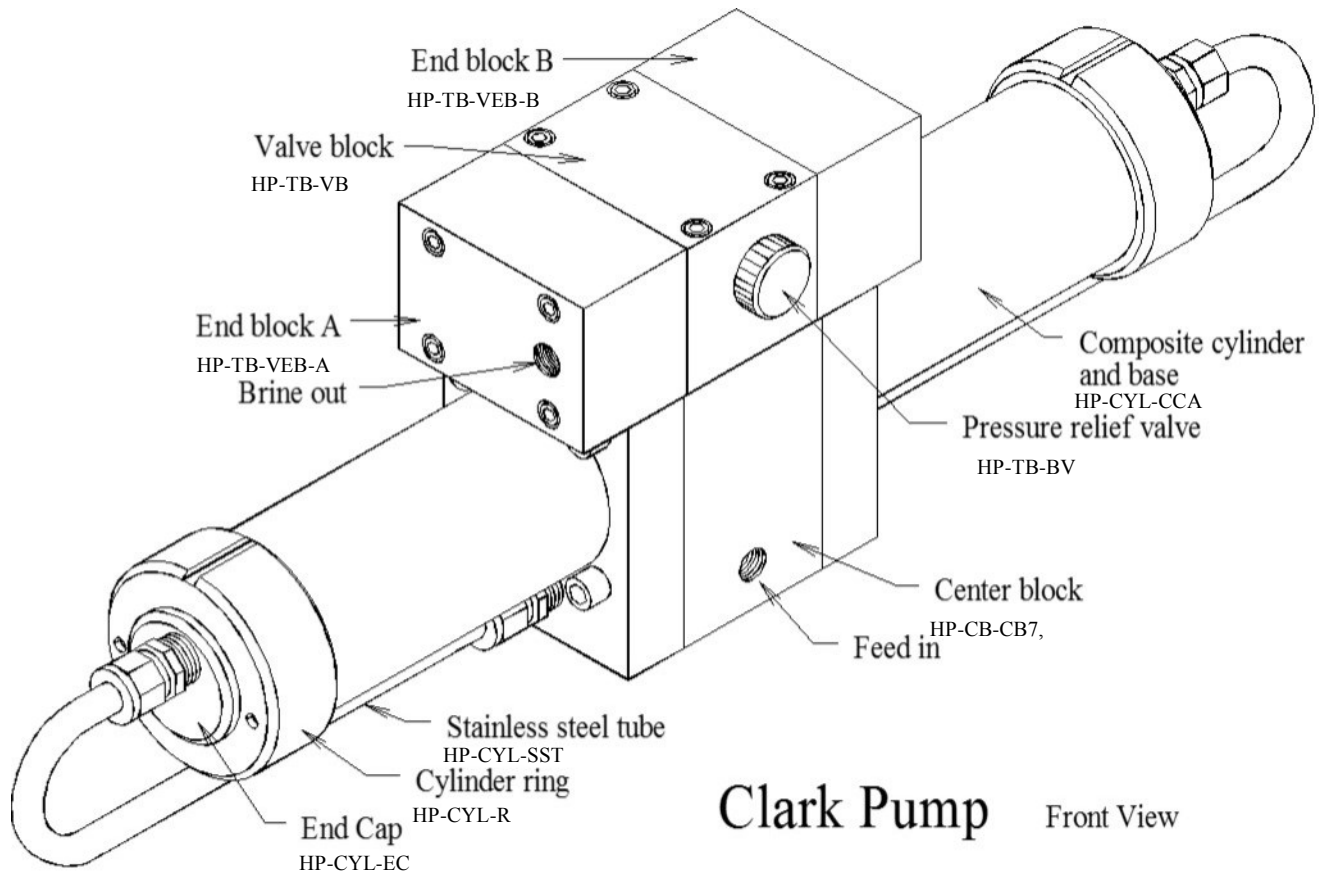

**Clark Pump** Front View

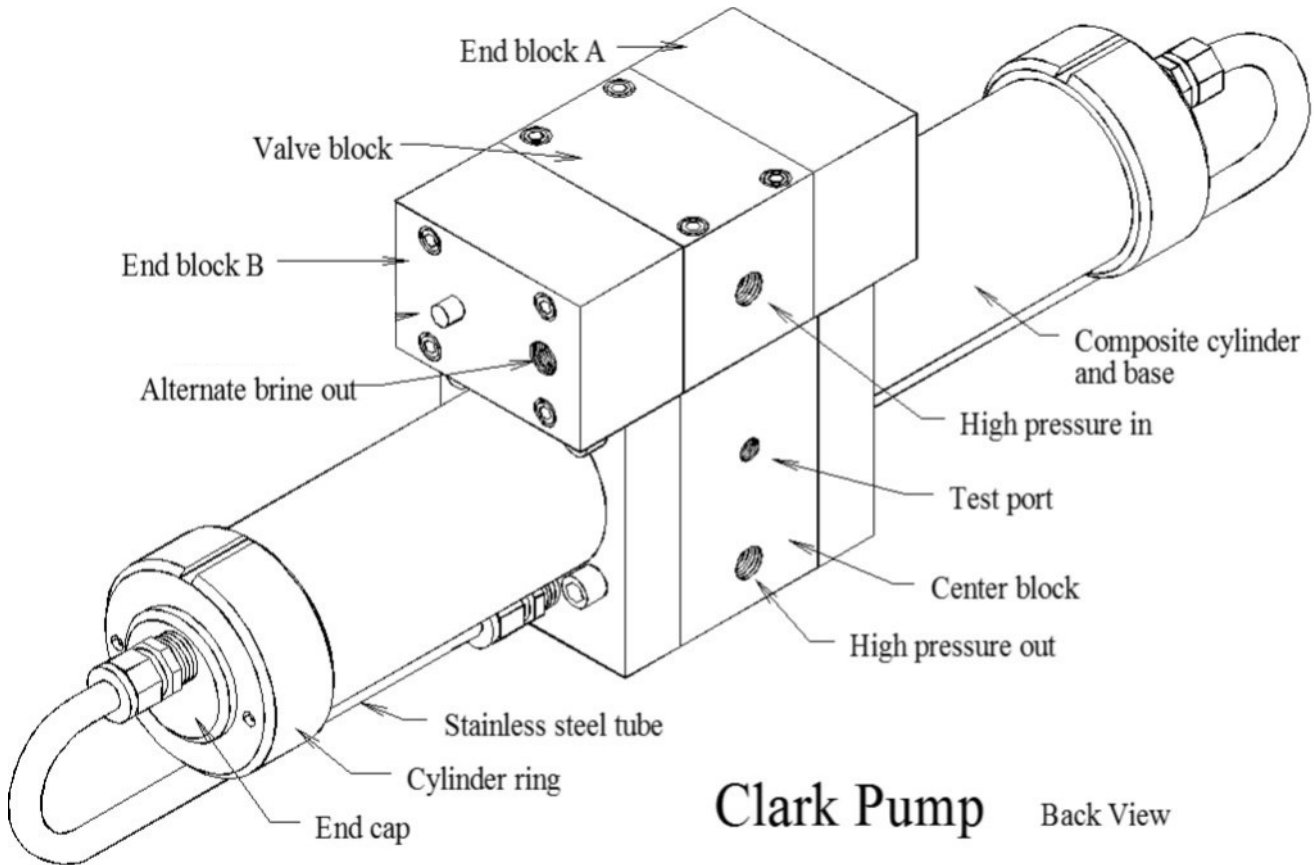

**Clark Pump** Back View

Spool Assembly  
Exploded View

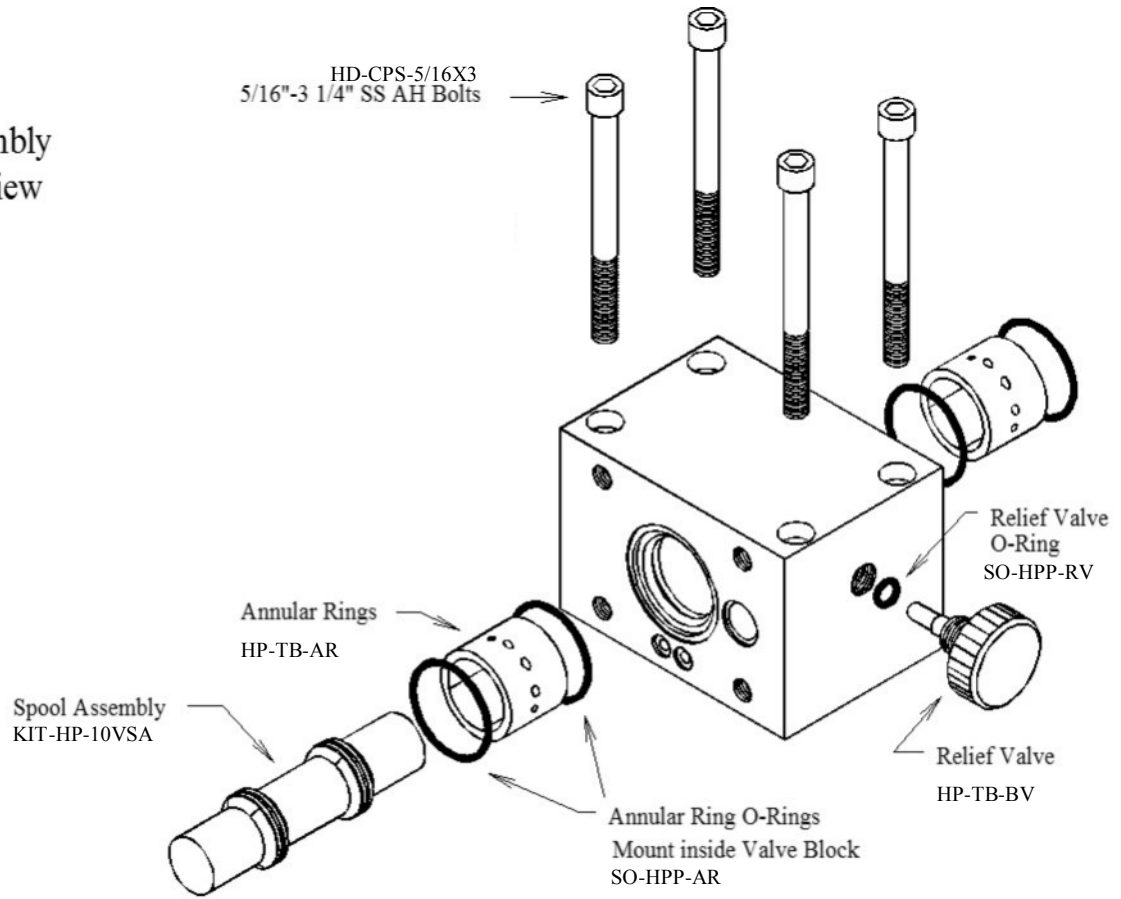

Valve Block

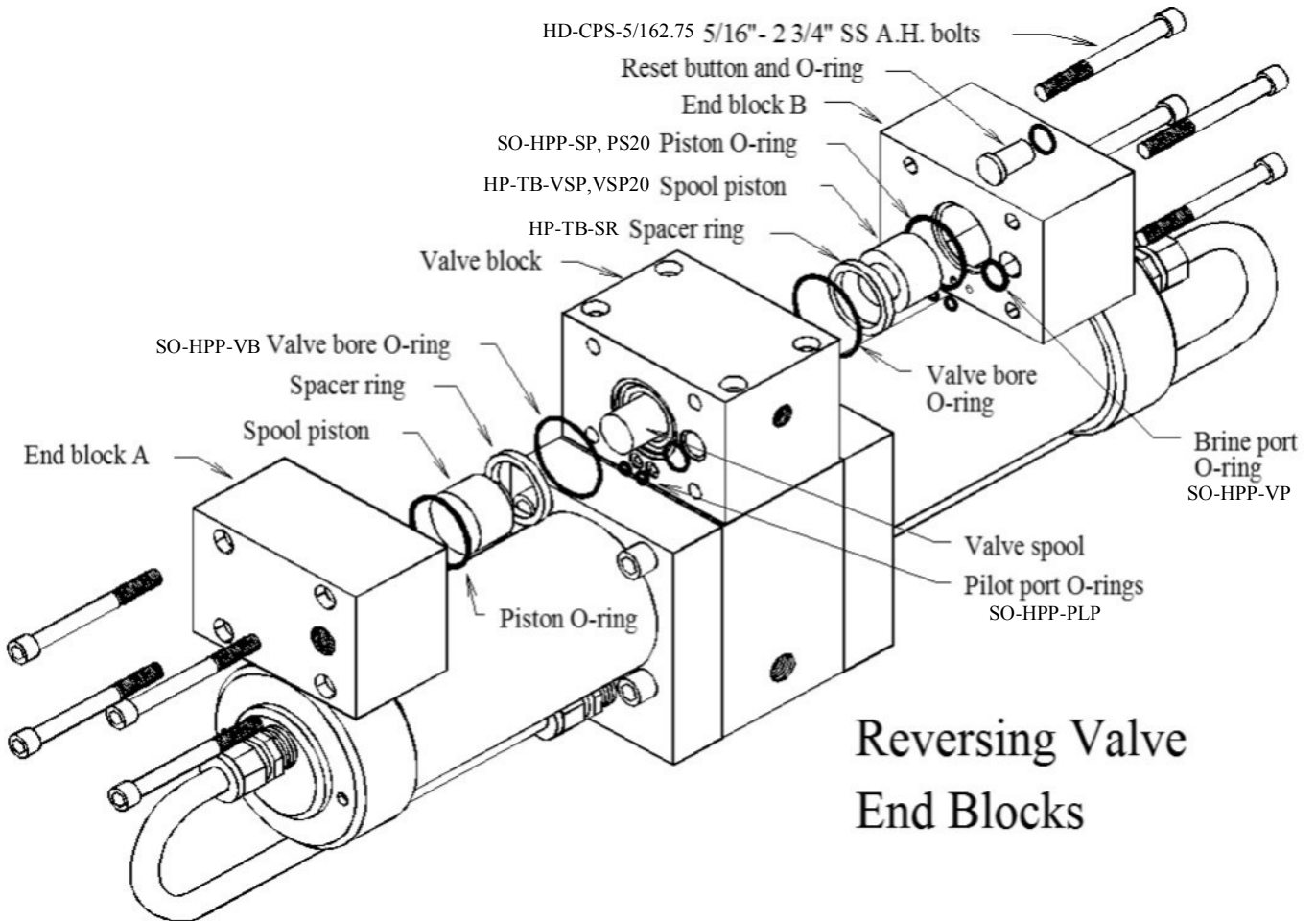

Reversing Valve  
End Blocks

# Parts

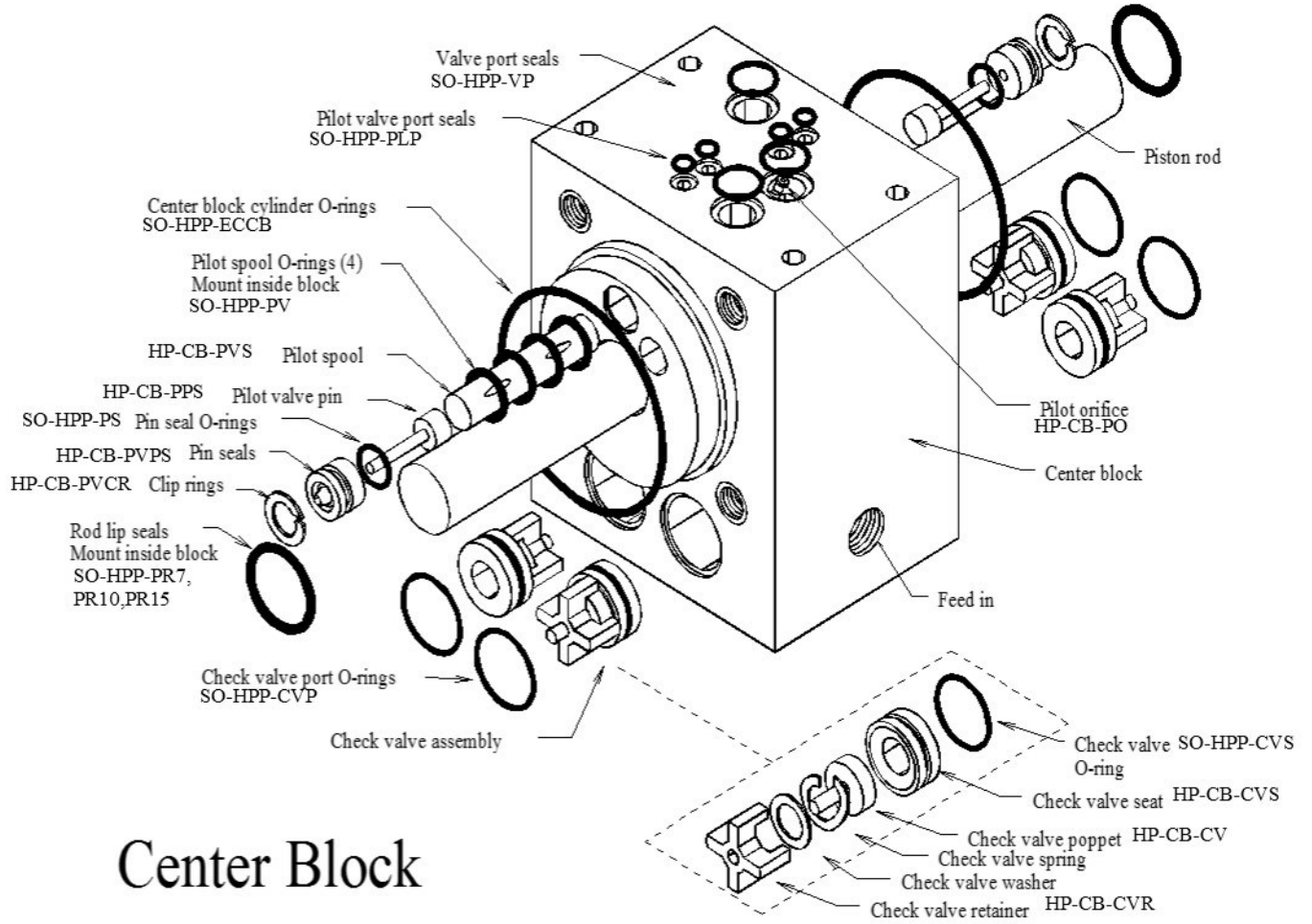

# Center Block

# Parts

